

USB HD Video Conference Camera

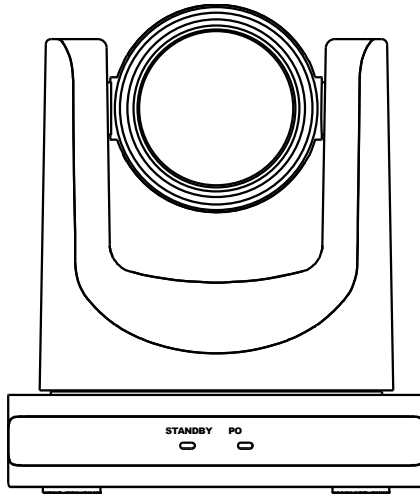

User Manual English (V1.1)

Copyright Notice

All contents of this manual, whose copyright belongs to our corporation cannot be cloned, copied or translated without the permission of the company. Product specifications and information which were referred to in this document are for reference only. We may change, delete, or update any content at any time and without prior notice.



Warning

This is class A production. Electromagnetic radiation at specific frequencies may affect the image quality of TV in home environment.

Catalogue

1)Note.....	4
2)Packing List.....	4
3)Quick Start.....	4
4)Please check connections are correct before starting.....	4
5)Connect the power adapter to the power connector on the rear panel of the camera. The power indicator on the front panel of the camera turns on.....	6
6)After the camera is powered on, it starts to initialize, upper right turns to the limit position, and then the horizontal and vertical turn to the middle position. When the motor stops running, it means that the initialization is completed. (Note: If preset 0 is saved, the PTZ will turn to preset 0).....	6
7)About Product.....	6
Features.....	6
Product Specification.....	6
Interfaces and Buttons.....	8
Dimension.....	8
Remote Control.....	9
RS232 Interface.....	10
Serial Communication Control.....	10
8)GUI Settings.....	11
MENU.....	11
EXPOSURE.....	11
COLOR.....	12
IMAGE.....	12
P/T/Z.....	12
NOISE REDUCTION.....	13
SETUP.....	13
COMMUNICATION SETUP.....	13
RESTORE DEFAULT.....	14
9)Network Function.....	14
Operating Environment.....	14
Equipment Installation.....	14
1)Connect the camera to the network or connect it directly to the PC with a network cable.....	14
1)Power on Camera.....	14
2)When the network connection in normal condition, the connect indicator at network interface will light up and the data indicator will flash to indicating that the physical connection of the camera has been completed.....	14
Internet Connection.....	14
Camera Controlled by LAN.....	14
Setup IP Address.....	14
1. Visit/Access Camera.....	16
Camera Controlled by WAN.....	16
Setup IP Controlled by Dynamic DNS.....	16
Camera Visiting via Dynamic DNS.....	16
VLC Stream Media Player Monitoring.....	16
Camera Parameter Setup.....	17
Homepage Introduction.....	17
1)Video Pause: Click to pause the real-time video, click again to resume.....	17
3)Full screen switch button.....	17
Video Settings.....	18
Image Settings.....	19
Audio Settings.....	19
System Settings.....	20

Network Settings.....	20
Device Information.....	21
Download the Network Upgrade Program.....	21
10)Maintenance and Troubleshooting.....	22
1)Check that the camera installation position is stable.....	22
4)Check that any vibrating machinery or object near the camera.....	22
1)Using PC to access the network to test that the network access can work properly to eliminate the network fault caused by cable and PC virus until the PC and camera can ping each other.....	22
11)Disconnect the network, connect camera with PC separately and reset the IP address of PC if necessary.....	22
12)Check that the IP address, subnet mask and gateway settings is correct.....	22
5)Check that the MAC address is conflicts.....	22
6)Check that the web port is modified, the default setting is 80.....	22
1)Check and replace with new batteries.....	22
7)Check that the camera is in normal working mode.....	22
8)Check the address key of remote control can match the camera.....	22
1)Check the protocol, address and bit rate of the camara are consistent.....	22
13)Check the control cable is properly connected.....	22

1) Note

Electric Safety

Installation and operation must accord with electric safety standard.

Caution to Transport

Avoid stress, vibration or soakage in transport, storage and installation.

Polarity of Power Supply

The power supply of this product is DC 12V, polarity of the power supply plug drawing shows as below.



Installation Precautions

Do not grasp the camera lens when carrying it. Don't touch camera lens by hand. Mechanical damage may be caused by doing so.

Do not use in corrosive liquid, gas or solid environment to avoid any cover (plastic material) damage. Make sure there is no obstacle within rotation range.

Please never power on before installation is completed.

Do not Dismantle the Camera

We are not responsible for any unauthorized modification or dismantling.



Warning

Specific frequencies of electromagnetic field may affect the image of the camera!

2) Packing List

When unpacking the package, check that all the supplied accessories are included:

Name	Quantity
Camera	1
Power Adapter	1
Power Cable	1
USB Cable	1
Remote Control	1
User Manual	1

3) Quick Start

4) Please check connections are correct before starting.

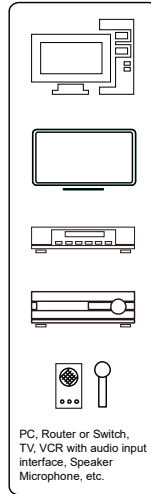
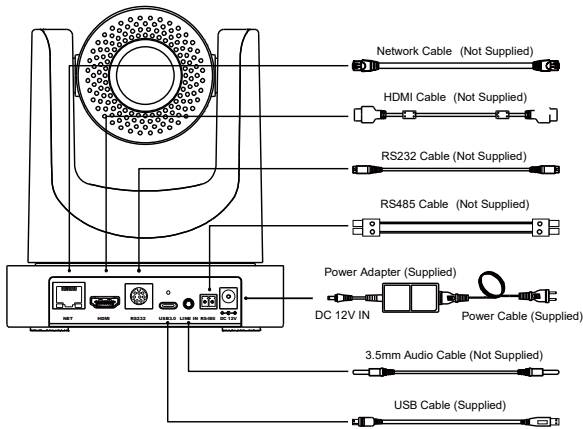

- 5) Connect the power adapter to the power connector on the rear panel of the camera. The power indicator on the front panel of the camera turns on.
- 6) After the camera is powered on, it starts to initialize, upper right turns to the limit position, and then the horizontal and vertical turn to the middle position. When the motor stops running, it means that the initialization is completed. (Note: If preset 0 is saved, the PTZ will turn to preset 0).

7) About Product

Features

Full Function USB Interface

Full function USB interface, compatible with USB 3.0 and USB 2.0, support audio and encoding output, and support the UVC V1.1 protocol.

1080P Full HD

High-quality HD CMOS sensor with 2.07 million effective pixels for high-quality images up to 1920x1080.

72.5° Wide-angle-lens +16x Digital Zoom

The exclusively customized 72.5° high-quality ultra-wide-angle lens, support 12x optical zoom and 16x digital zoom.

Low Illumination

The new CMOS image sensor with ultra-high SNR can effectively reduce the image noise under low illumination. The application of 2D and 3D noise reduction algorithm greatly reduces the image noise even under the condition of ultra-low illumination, it keeps the picture clean and clear, and the SNR of image is as high as 55dB.

PoE

The wired network supports PoE power supply, the control, power supply, video and audio can be completed with a network cable.

● Remote Control

The camera can be controlled remotely through the RS232, RS485, network and USB port.

● H.264 Slice/H.264 SVC

The H.264 stream supports Slice and SVC encoding modes, and suitable for high-end USB conference video applications.

● Dual Stream

Support two stream output (YUY2, MJPEG, H.264 each of both) to reduce the host codec pressure.

● Multiple & Complete Interfaces

Support 1080P video output through HDMI, USB 3.0 and network simultaneously.

● Three Power Supply Modes

Simultaneously support USB 5V, 12V power adapter and PoE power supply.

● High Frame Rate

1080P output frame rate up to 60fps.

Product Specification

Name	USB HD Video Conference Camera
Camera	
Video System	1080P/60, 1080P/50, 1080P/30, 1080P/25, 720P/60, 720P/50
Sensor	1/2.8 inch, CMOS, Effective Pixel: 2.07M
Scanning Mode	Progressive
Lens	12x, f=3.5mm ~ 42.3mm, F1.8 ~ F2.8
Digital Zoom	16x
Minimum Illumination	0.5 Lux @ (F1.8, AGC ON)
Shutter	1/30s ~ 1/10000s
White Balance	Auto, Indoor, Outdoor, One Push, Manual, VAR
Backlight Compensation	Support
Digital Noise Reduction	2D & 3D Digital Noise Reduction
Signal Noise Ratio	≥55dB

Horizontal Angle of View	72.5° ~ 6.9°
Vertical Angle of View	44.8° ~ 3.9°
Horizontal Rotation Range	±170°
Vertical Rotation Range	-30° ~ +90°
Pan Speed Range	2.7° ~ 35.7°/s
Tilt Speed Range	2.7° ~ 31.5°/s
H & V Flip	Support
Image Freeze	Support
Number of Preset	255
Preset Accuracy	0.1°

Network Features

Video Compression	H.264/MJPEG
Video Stream	First Stream, Second Stream
First Stream Resolution	1920x1080, 1280x720, 1024x576, 960x540, 640x480, 640x360
Second Stream Resolution	1280x720, 1024x576, 720x576 (50Hz), 720x480 (60Hz), 720x408, 640x360, 480x272, 320x240, 320x180
Video Bit Rate for First Stream	32Kbps ~ 20480Kbps
Video Bit Rate for Second Stream	32Kbps ~ 6144Kbps
Bit Rate Control	CBR, VBR
Frame Rate	50Hz: 1fps ~ 50fps, 60Hz: 1fps ~ 60fps
Audio Type	AAC
Audio Bit Rate	96Kbps, 128Kbps, 256Kbps
Protocols	TCP/IP, HTTP, RTSP, RTMP(S), ONVIF, DHCP, Multicast, etc.

USB Features

Operate System	Windows 7, Windows 8, Windows 10, Mac OS X, Linux, Android
Color System / Compression	MJPEG/YUY2/H.264
Video Format	<ul style="list-style-type: none"> ● YUY2:1080P@60fps (max.) ● H.264 AVC: 1080P@60fps (max.) ● H.264 SVC: 1080P@60fps (max.) ● MJPEG: 1080P@60fps (max.)
USB Audio	Support
USB Video Communication Protocol	UVC 1.1
UVC PTZ	Support

Input/Output Interface

Network Interface	1 x NET: 10M/100M Adaptive Ethernet Port
USB Interface	1 x USB 3.0: Type-C
LINE IN Interface	1 x LINE IN: 3.5mm Audio Interface
Communication Interface	1 x RS232: 8pin Min DIN, Max. Distance: 30m, Protocol: VISCA/Pelco-D/ Pelco-P 1 x RS485: 2pin phoenix port, Max. Distance: 1200m, Protocol: VISCA/ Pelco-D/Pelco-P
HDMI Output Interface	1 x HDMI 1.4b
Power Jack	JEITA type (DC IN 12V) /USB Type-C (DC IN 5V) /PoE

Physical Parameter

Input Voltage	DC 12V/DC 5V /PoE (802.3af)
Current Consumption	12V 1.0A (max.) /5V 1.5A (max.)
Operating Temperature	-10°C ~ 40°C
Storage Temperature	-40°C ~ 60°C

Remote Control

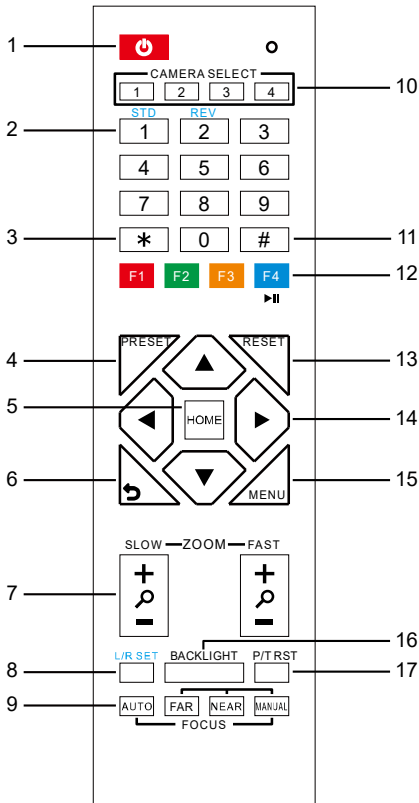

Key Description

1. ⏻ (Standby) Key

Press to enter standby mode. Press again to resume to normal mode.

Note: The power consumption in standby mode is approximately half of that in normal mode.

2. Number Key

To set preset or call preset.

3. * Key

Use with other keys.

4. PRESET Key

Set preset: Store a preset position.
[PRESET] + Number key (0-9): Set a corresponding preset position.

5. HOME Key

Confirm selection or press to turn PTZ back to

the middle position.

6. ↶ (Return) Key

Press to return to the previous menu.

7. ZOOM Key

SLOW: Zoom In [+] or Zoom Out [-] slowly.
FAST: Zoom In [+] or Zoom Out [-] fast.

8. L/R SET Key

Press with 1 or 2 key to set the direction of the Pan-Tilt.

Simultaneously press L/R SET + 1 [STD]: Set the Pan-Tilt turn the same direction as the PTZ control key.

Simultaneously press L/R SET + 2 [REV]: Set the Pan-Tilt turn the opposite direction as the PTZ control key.

9. FOCUS Key

Focus adjustment:

Press [AUTO] to adjust the focus automatically.

Press [MANUAL] to adjust the focus manually. When in manual focus mode, press [FAR] to focus on far object or [NEAR] to focus on near object.

10. CAMERA SELECT Key

Camera selection:

Press to select and control the camera.

11. # Key

Use with other keys.

12. IR Remote Control Key

[*] + [#] + [F1]: Address 1

[*] + [#] + [F2]: Address 2

[*] + [#] + [F3]: Address 3

[*] + [#] + [F4]: Address 4

13. RESET Key

Clear the preset position:

[RESET] + Number key (0-9).

Or: [*] + [#] + [CLEAR PRESET]: Erase all the preset individually.

14. PTZ Control Key

Press arrow button to perform panning and tilting. Press [HOME] button to face the camera back to front.

15. MENU Key

Enter or exit OSD MENU.

16. BACKLIGHT Key

Backlight ON/OFF: Press repeatedly to enable or disable the backlight compensation.

NOTE:

Effective only in auto exposure mode.

If there is a light behind the subject, the subject will become dark, press the backlight key to enable the backlight compensation.

Press again to disable this function.

17. P/T RST (PTZ Reset) Key

Press to preset Pan/Tilt self-test.

18. Image Freezing Function

Manual freeze: Press the [F4] key to open the freezing function, "Freeze" will be displayed on the left upper corner. To cancel the freeze function, press [F4] key again, "Unfreeze" shows on the left upper corner and it will be disappeared automatically five seconds later. Image freeze when recalling the preset: After enable the "Image Freeze" function by the OSD menu setting, the screen will remain the previous image when recalling the preset. The screen will switch to the preset image after the camera turn to the preset position.

19. Shortcut Set

[*] + [#] + [1]: OSD menu default English
[*] + [#] + [3]: OSD menu default Chinese
[*] + [#] + [4]: Display current IP address
[*] + [#] + [6]: Quickly recover the default
[*] + [#] + [8]: View the camera version
[*] + [#] + [9]: Quickly set up inversion
[*] + [#] + [MANUAL]: Restore to default IP address.

RS232 Interface

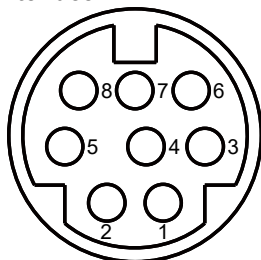

No.	Function
1	DTR
2	DSR
3	TXD
4	GND
5	RXD
6	GND
7	IR OUT

No.	Function
8	NC

The correspondence between the camera and Windows DB-9 pin:

Camera	Windows DB-9
1.DTR	1.CD
2.DSR	2.RXD
3.TXD	3.TXD
4.GND	4.DTR
5.RXD	5.GND
6.GND	6.DSR
7.IR OUT	7.RTS
8.NC	8.CTS
	9.RI

The correspondence between the camera and the Mini DIN pin:

Camera	Mini DIN
1.DTR	1.DTR
2.DSR	2.DSR
3.TXD	3.TXD
4.GND	4.GND
5.RXD	5.RXD
6.GND	6.GND
7.IR OUT	7.NC
8.NC	8.NC

Serial Communication Control

RS232 Communication Control

Camera controlled via RS232. The RS232 serial port parameters are as follows:

Baud rate: 2400/4800/9600/38400

Starting Position: 1 bit

Data bits: 8 bits

Stop bits: 1 bit

Parity: None

RS485 Communication Control

Camera controlled via RS485, half duplex mode:

Baud rate: 2400/4800/9600/38400

Starting position: 1 bit

Data bit: 8 bits

Stop bit: 1 bit

Check digit: None

After power on, the camera goes to the upper right limit and then back to the middle position.

The lens pulled to the farthest position (auto focus) and the aperture will be adjusted to the default value. If preset 0 is saved, the PTZ will be turn to position 0 after the initialization is completed. Use the serial port command to control the camera.

List of protocols (omitted)

The serial port of the camera follows the VISCA/Pelco-D/Pelco-P standard protocol. If secondary development is required, the camera can be controlled according to the standard protocol.

For a detailed list of VISCA/Pelco-D/Pelco-P protocols, please contact with manufacturer.

8) GUI Settings

MENU

Press [MENU] key to display the main menu on the screen. Use the arrow key to move the cursor to desired item and press the [HOME] key to confirm to enter the corresponding sub-menu.

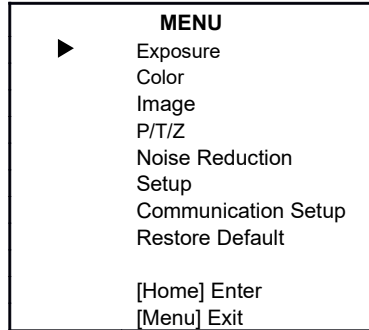

EXPOSURE

When in main menu page, move the cursor to [Exposure] and press [HOME] key to confirm to enter the exposure page as shown in below figure.

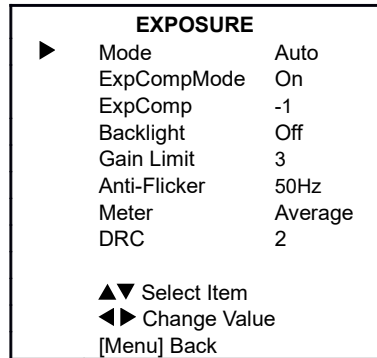

Mode: Auto, Manual, SAE, AAE, Bright.

ExpCompMode (Exposure Compensation Mode): On, Off (Effective only in Auto mode).

ExpComp (Exposure Compensation Value): -7 ~ +7 (Effective only in ExpCompMode On).

Backlight: On, Off (Effective only in Auto mode).

Bright: 0~17 (Effective only in Bright mode).

Gain Limit: 0 ~ 15 (Effective in Auto, SAE, AAE, Bright mode).

Anti-Flicker: Off, 50Hz, 60Hz (Effective in Auto, AAE, Bright mode).

Meter: Average, Center, Smart, Top (Effective in Auto, SAE, AAE, Bright mode).

Iris: F1.8, F2.0, F2.4, F2.8, F3.4, F4.0, F4.8, F5.6, F6.8, F8.0, F9.6, F11.0, Close (Effective in Manual, AAE mode).

Shutter: 1/30, 1/60, 1/90, 1/100, 1/125, 1/180, 1/250, 1/350, 1/500, 1/725, 1/1000, 1/1500, 1/2000, 1/3000, 1/4000, 1/6000, 1/10000 (Effective in Manual, SAE mode).

Gain: 0 ~ 7 (Effective only in Manual mode).

DRC: 0 ~ 8.

COLOR

When in main menu page, move the cursor to [Color] and press [HOME] key to confirm to enter the color page as shown in below figure.

COLOR		
▶	WB Mode	Auto
	RG Tuning	+1
	BG Tuning	+1
	Saturation	100%
	Hue	7
	AWB Sens	High
▲▼ Select Item		
◀▶ Change Value		
[Menu] Back		

WB-Mode (White Balance Mode): Auto, Indoor, Outdoor, One Push, Manual, VAR.

RG Tuning (Red Gain Tuning): -10 ~ +10 (Effective only in Auto, One Push, VAR mode).

BG Tuning (Blue Gain Tuning): -10 ~ +10 (Effective in Auto, One Push, VAR mode).

Saturation: 60% ~ 200%.

Hue: 0 ~ 14.

AWB Sens (The White Balance Sensitivity):

Low, Middle, High (Effective in Auto, One Push mode).

RG (Red Gain): 0~255 (Effective only in Manual mode).

BG (Blue Gain): 0~255 (Effective only in Manual mode).

Color Temp: 2500K ~ 8000K (Effective only in VAR mode).

IMAGE

When in main menu page, move the cursor to [Image] and press [HOME] key to confirm to enter the image page as shown in below figure.

IMAGE		
▶	Luminance	7
	Contrast	7
	Sharpness	4
	Flip-H	Off
	Flip-V	Off
	B&W-Mode	Off
	Gamma	Ext
	Style	Default
▲▼ Select Item		
◀▶ Change Value		
[Menu] Back		

Luminance: 0 ~ 14.

Contrast: 0 ~ 14.

Sharpness: Auto, 0 ~ 15.

Flip-H: On, Off.

Flip-V: On, Off.

B&W-Mode: On, Off.

Gamma: Ext, Default, 0.45, 0.5, 0.56, 0.63.

Style: Default, Norm, Clarity, Bright, PC.

P/T/Z

When in main menu page, move the cursor to [P/T/Z] and press [HOME] key to confirm to enter the P/T/Z page as shown in below figure.

P/T/Z		
▶	SpeedByZoom	On
	AF-Zone	Front
	AF-Sense	High
	Display Info	On
	Image Freeze	Off
	Digital Zoom	Off
	Call Preset Speed	22
	Pre Zoom Speed	5
▲▼ Select Item		
◀▶ Change Value		
[Menu] Back		

SpeedByZoom (The Depth of Field Ratio): On, Off.

AF-Zone (Auto Focus Area): Front, Top, Center, Bottom.

AF-Sense (Auto Focus Sensitivity): Low, Normal, High.

Display Info: On, Off.

Image Freeze: On, Off.

Digital Zoom: Off, 2x, 4x, 8x, 16x.

Call Preset Speed: 1 ~ 24.

Pre Zoom Speed: 0 ~ 7.

NOISE REDUCTION

When in main menu page, move the cursor to [Noise Reduction] and press [HOME] key to confirm to enter the noise reduction page as shown in below figure.

NOISE REDUCTION		
▶	NR2D-Level	Auto
	NR3D-Level	Auto
▲▼ Select Item		
◀▶ Change Value		
[Menu] Back		

NR2D Level (2D Noise Reduction): Auto, Off, 1 ~ 5.

NR3D Level: (3D Noise Reduction): Auto, Off, 1 ~ 8.

SETUP

When in main menu page, move the cursor to [Setup] and press [HOME] key to confirm to enter the setup page as shown in below figure.

SETUP		
▶	Language	EN
	Video Format	1080P30
	USB Mode	ISOC
	OSD Flip	Off
	USB Audio	On
	UVC H264	On
▲▼ Select Item		
◀▶ Change Value		
[Menu] Back		

Language: EN, Chinese, Russian.

USB Format: 1080P60, 1080P50, 1080P30, 1080P25, 720P60, 720P50.

USB Mode: BULK, ISOC.

OSD Flip: On, Off.

USB Audio: On, Off.

UVC H264: On, Off.

COMMUNICATION SETUP

When in main menu page, move the cursor to [Communication Setup] and press [HOME] key to confirm to enter the communication setup page as shown in below figure.

COMMUNICATION SETUP		
▶	Protocol	VISCA
	V_Address	1
	V_AddrFix	Off
	Net Mode	Serial
	Baudrate	9600
▲▼ Select Item		
◀▶ Change Value		
[Menu] Back		

Protocol: Auto, VISCA, PELCO-D, PELCO-P.

V_Address: 1 ~ 7 (Effective in Auto, VISCA protocol).

V_AddrFix: On, Off (When set to On, the 88 30 01 FF command does not work. Effective in Auto and VISCA protocol).

P_D_Address: 0 ~ 254. (Effective in Auto,

PELCO-D protocol).

P_P_Address: 0 ~ 31. (Effective in Auto, PELCO-P protocol).

Net Mode: Serial, Paral (Effective in Auto, VISCA protocol).

Baudrate: 2400, 4800, 9600, 38400.

RESTORE DEFAULT

When in main menu page, move the cursor to [Restore Default] and press [HOME] key to confirm to enter the restore default page as shown in below figure.

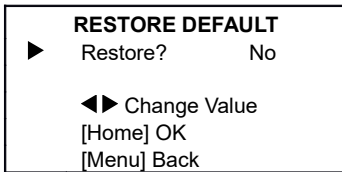

Restore: Yes, No.



Notice

When selected "Yes" and confirm with [HOME] key, all parameters will restore to default, include the IR Remote address and VISICA address.



Note

GUI menu and parameters are subject to change without notice.

9) Network Function

Operating Environment

Operating System: Windows 7, Windows 8, Windows 10, Mac OS X, Linux, Android.

Network Protocol: TCP/IP

PC Configuration: P4/128M RAM/40G HDD support scaled graphics card, support DirectX 8.0 or more advanced version.

Equipment Installation

- 1) Connect the camera to the network or connect it directly to the PC with a network cable.
- 1) Power on Camera.
- 2) When the network connection in normal condition, the connect indicator at network interface will light up and the data indicator will flash to indicating that the physical connection of the camera has been completed.

Internet Connection

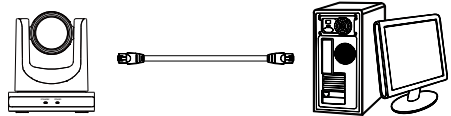

Connect by Network Cable

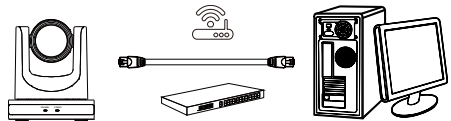

Connect by Switch/Router

Camera Controlled by LAN

Setup IP Address

The factory default IP is: 192.168.100.88, If you don't know the camera IP, check it as below:

Method 1: Press * and # and 4 on remote control one by one, the camera IP address will be shown on screen.

Method 2: Connect the camera to PC with network cable, check the IP address with "upgrade_En.exe".



upgrade

Change IP address, two methods as below:

Method 1: Input the IP address, username and password to login the web page, select "Network > Lan Settings" to change the IP

address. Click “Submit” and restart the camera to take effect the new IP address.

Lan Settings

IP Configuration Type: Fixed IP Address

IP Address: 192.168.100.88

Subnet Mask: 255.255.255.0

Gateway: 192.168.100.1

DNS Address: 8.8.8.8

MAC Address: D4:E0:8E:BD:00:D6

Submit Cancel

Port Settings

HTTP Port: 80

RTSP Port: 554

TCP Port: 5678

UDP Port: 1259

Sony Visca: 52381

RTMP(S) Settings

First Stream: On Off Video Audio

MRL: rtmp://192.168.100.138/live/stream0

Second Stream: On Off Video Audio

MRL: rtmp://192.168.100.138/live/stream1

SRT Settings

SRT: On Off

SRT Port: 4578

SRT Encryption: None

SRT Password: 1234567890

RTSP Settings

RTSP Auth: On Off

ONVIF Settings

ONVIF: On Off

ONVIF Auth: On Off

Multicast Settings

Multicast: On Off

Address: 224.1.2.3

Port: 6688

NTP Settings

NTP time sync: On Off

Time Zone: (GMT+08:00) Beijing, Chk

Server address: cn.ntp.org.cn

Time Interval(min): 1440

Main time show: On Off

Position: X 0 Y 0

Sub time show: On Off

Position: X 0 Y 0

Submit Cancel

Config Backup

Mode: Manual Snapshot

IP Address: 192.168.100.88

NetMask: 255.255.255.0

GateWay: 192.168.100.1

First DNS: 8.8.8.8

MAC Address: D4 : E0 : 8E : A0 : 41 : F5

Set Rewrite Default

Change IP address:
Search the IP address of camera.
Select the camera IP that you want to change.
Select the “Config” dialog of upgrade applets.
Change the IP address, Netmask and Gateway, then click “Set”.
Finish.

Method 2: Open “upgrade_en.exe”, Select the “Config” dialog, change IP Address and click “Set”. After modified, the video conference camera will be restart.

1. Visit/Access Camera

Visit <http://192.168.100.88> via IE (better with IE web browser, others will cause latency), the login window will pop up as below, input the username and password.



After login, it will show as below:



Tips

IE browser does not support H5, you need to use VLC plug-in to view videos. Please visit VLC website (<http://www.videolan.org/vlc>) to download and install the 32-bit VLC media player, after installation, the video image will be displayed normally when visit the camera. Other mainstream browsers already support H5 and do not need to install the VLC plug-in.

Camera Controlled by WAN

Setup IP Controlled by Dynamic DNS

Two dynamic DNS: Dyndns.org, 3322.org.

Router Port Mapping (Tenda):

Enter the Router Home Page (interface page), select "Advanced"- "Virtual Server" > enter a new port number in "Ext Port" > enter a new port number in "Int port" > enter the IP

address to "Internal IP" > select "Save" as below:

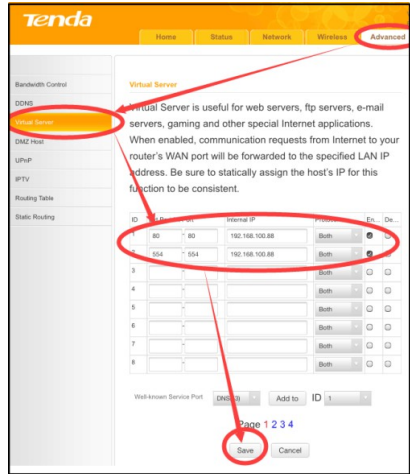

Camera Visiting via Dynamic DNS

Set domain name to camera, after configured the parameters, you can use the dynamic DNS to visit camera. Access link:

<http://hostname:port number>. If the computer is: youdomain.f3322.org, and the camera port is 89, the access link should be <http://youdomain.3322.org:89>.



Tips

If the camera port is 80, you do not need to input port number, use the host name to access camera directly.

VLC Stream Media Player Monitoring

Visit VLC Media Server Procedure

Step 1 Open VLC media player.

Click "Media > Open Network Stream", or click "Ctrl + N" as below:

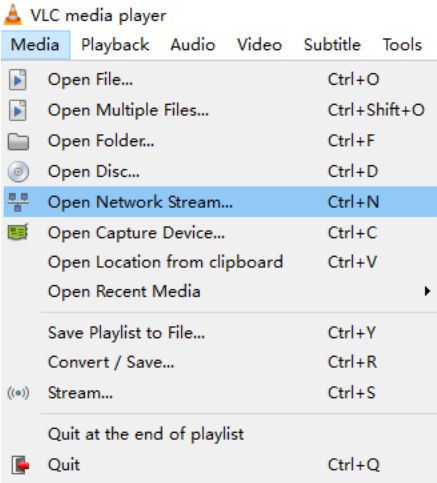

Input URL address:
 rtsp://ip: port number/1 (First stream);
 rtsp://ip: port number/2 (Second stream).

Finish.



Tips

The default RTSP port number is 554.

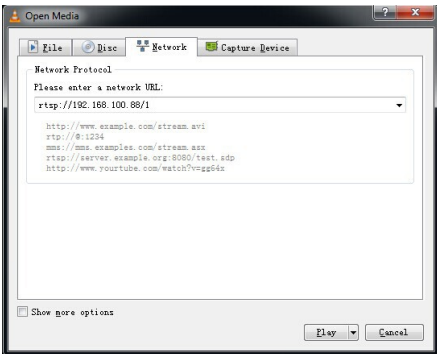

Camera Parameter Setup Homepage Introduction

Menu

The interface includes below two menu bars:
 Real Time Monitoring: Video image displaying
 Parameter Setup: Configure the parameters.

A. Video Viewing Window

The video viewing window is same as video resolution, the bigger the resolution, the bigger the playing area. Double click the viewing window to show full screen, double click again to return to initialized size.

The status bar in viewing window is shown as below:



- 1) Video Pause: Click to pause the real-time video, click again to resume.
- 3) Full screen switch button.

B. PTZ

Setup

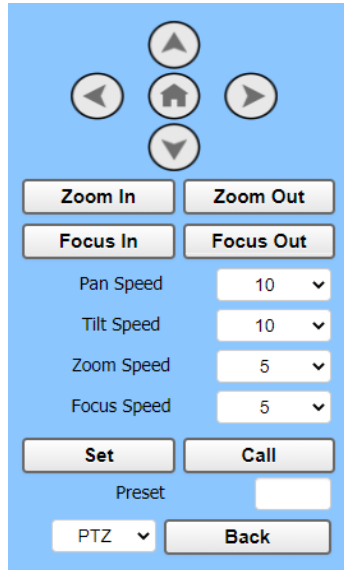

1) Pan and Tilt Control

The Up, Down, Left and Right arrow and HOME button allow you to manually drive the camera to the desired position.

Zoom

Zoom In and Zoom Out button allow for wide

or narrow view of the space.

Focus

Focus In and Focus Out button allow for fine manual focus adjustment if the camera has any auto focusing problems on difficult object.

PTZ Speeds

Pan speed rate can be set to 1 ~ 24, Tilt speed rate can be set to 1 ~ 20. Zoom and Focus speed rate can be set to 0 ~ 7.

PTZ Presets

When the PTZ turns to the position that you would like to return to later, you can set presets for quick recall.

Step 1 Type a number into the preset box.

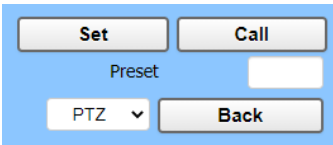

Click "Set" to save the preset.

When the PTZ turn to other position, input the preset number and click "Call" button to turn the PTZ back to the preset position.

PTZ/OSD

Move the cursor to dropdown menu, select and click "OSD" to open the on-screen menu and do menu settings on the interface.

C. Language Selection

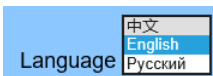

Click to select "Chinese", "English" or "Russian" to change the language of the interface.

Video Settings

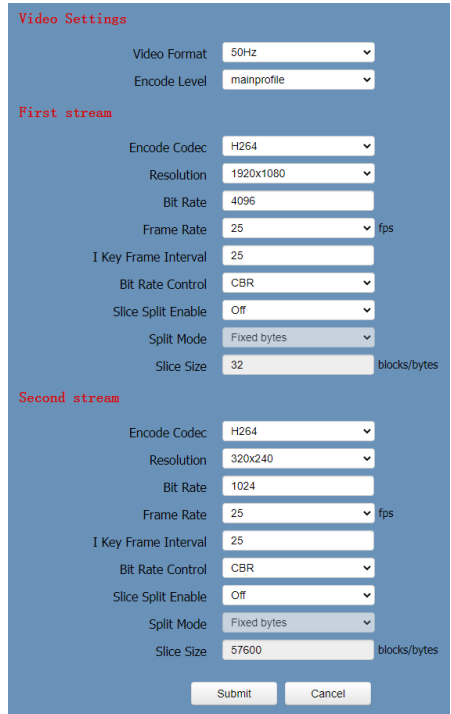

1) Video Format

Support 50Hz (PAL) and 60Hz (NTSC) formats.

Encode Level

Support baseline, mainprofile and highprofile.

Encode Codec

Support H264 and MJPEG.

Resolution

First stream support 1920x1080, 1280x720, 1024x576, 960x540, 640x480, 640x360. Second stream support 1280x720, 1024x576, 720x576 (50Hz), 720x480 (60Hz), 720x408, 640x360, 480x272, 320x240, 320x180; The bigger the resolution, the clearer the image, and the larger the code stream, the more network bandwidth will be taken.

Bit Rate

You can specify the bit rate, the larger of the bit rate, the clearer of the image. The configuration of the bit rate needs to be combined with the network bandwidth. When the network bandwidth is narrow and the bit rate is configured larger, the video stream cannot be transmitted normally, and the visual effect will be worse.

Frame Rate

You can specify the size of the frame rate, the greater the frame rate, the smoother the image, the smaller the frame, the more sense of beating.

I Key Frame Interval

Set the interval between two I frames, the bigger the interval, the slower the response when opening the image for the first time.

Bit Rate Control

Two modes for bit rate control:

CBR (Constant Bit Rate): Video coder will be coding according to the preset speed.

VBR (Variable Bit Rate): Video coder will adjust the speed based on preset speed to gain the best image quality.

Slice Split Enable

Enable or disable the Slice Split function.

Split Mode

Split Mode Fixed bytes.

Slice Size

Size for slice.

Image Settings



1) Brightness

Image Bright: 0~14 (Controlled by the slide bar, the digital value displayed on the right). Default is 7.

Saturation

Image Saturation: 0~14 (Controlled by the slide bar, the digital value displayed on the right). Default is 4.

Contrast

Image Contrast: 0~14 (Controlled by the slide bar, the digital value displayed on the right). Default is 7.

Sharpness

Image Sharpness: 0~16 (Controlled by the slide bar, the digital value displayed on the right). Default is 4.

Hue

Image Hue: 0~14 (Controlled by the slide bar, the digital value displayed on the right). Default is 7.

Flip & Mirror

Flip: Enable or disable the Flip function.

Mirror: Enable or disable the Mirror function.

Audio Settings

Audio Settings

Audio Switch ▾

Audio Type ▾

Sample Rate ▾

Bit Rate ▾

Input Type ▾

ADTS Options ▾

1) Audio Switch

Enable or disable audio switch.

Audio Type

Audio type AAC.

Sample Rate

Sample rate 48K.

Bit Rate

Bit rate 96K, 128K and 256K selectable.

Input Type

Input type Line in.

ADTS Options

Options: On, Off.

System Settings

Initialize

Reboot

User

UserName

Passwd

Guest

Passwd

1) Reboot

Click "Reboot" to restart system.

Username and Password

Modify the password of username and guest (use letters and Numbers only).

Network Settings

Lan Settings

IP Configuration Type ▾

IP Address

Subnet Mask

Gateway

DNS Address

MAC Address

Port Settings

HTTP Port

RTSP Port

TCP Port

UDP Port

Sony Visca

RTMP(S) Settings

First Stream On Off Video Audio

MRL

Second Stream On Off Video Audio

MRL

SRT Settings

SRT On Off

SRT Port

SRT Encryption ▾

SRT Password

RTSP Settings

RTSP Auth On Off

ONVIF Settings

ONVIF On Off

ONVIF Auth On Off

Multicast Settings

Multicast On Off

Address

Port

NTP Settings

NTP time sync On Off

Time Zone ▾

Server address

Time interval(min)

Main time show On Off

Position

Sub time show On Off

Position

1) Lan Settings

The default IP address is 192.168.100.88, the MAC address cannot be modified.

Port Settings

Set the HTTP, RTSP, TCP, UDP and Sony Visca port number of the camera.

A. HTTP Port

The IP address identifies a network device and multiple network programs can run on the device, each network program uses the network port for data transmission. The port setting on this page is to set up which port the WEB SERVER program uses to transmit.

During port mapping, it needs to be consistent with the port number (default is 80).

B. RTSP Port

Set up the RTSP port, default is 554.

C. TCP Port

Set up the TCP port, default is 5678.

D. UDP Port

Set up the UDP port, default is 1259.

E. Sony Visca

Sony Visca 52381.

RTMP(S) Settings

Set the MRL of RTMP(S) and select "on", "off", "video" and "audio" functions to enable or disable video and audio in the two streams.

SRT Settings

Turn On/Off SRT and set up the SRT Port, Encryption and Password.

RTSP Settings

Turn On/Off the RTSP Auth.

ONVIF Settings

Turn On/Off the ONVIF and ONVIF Auth.

1) Multicast Settings

Turn On/Off Multicast, set up the Multicast Address (default is 224.1.2.3) and Port (default is 6688; 6688 is the multicast port of the first stream and 6690 is the multicast port of the second stream).

NTP Settings

Turn On/Off NTP time sync, Main time show and Sub time show; select the Time Zone; set up the Server address, Time interval and the Time Show Position of the two streams.

Device Information

Display the current device information as below figure.



The screenshot shows a blue-themed interface titled "Information". It contains four input fields with the following values: Device ID: HD Camera; Device Type: G46 V; Software Version: SOC v9.0.32 - ARM 7.3.20S; Webware Version: v1.5.5. At the bottom right, there are two buttons: "Submit" and "Cancel".



The above information is for reference only, please refer to the real product for the actual specification.

Download the Network Upgrade Program

If you need the camera upgrade program, please contact the manufacturer.



WEB interface and parameters are subject to change without notice.

10) Maintenance and Troubleshooting

Camera Maintains

If camera will not be used for a long time, disconnect the AC power adapter from the AC outlet.

Use soft cloth or tissue to clean the camera cover.

Please use the soft dry cloth to clean the lens.

If the camera is very dirty, clean it with diluted neuter detergent. Do not use any type of solvents, which may damage the surface.

Unqualified Working Environment

Avoid shooting objects such as sunlight or light, etc.

Do not operate the camera under unstable lighting conditions, otherwise the image will be flickering.

Do not use the camera around powerful electromagnetic radiation, such as TV or radio transmitters, etc.

Troubleshooting

Image

Image jitters when the lens at the maximum multiple

- 1) Check that the camera installation position is stable.
- 4) Check that any vibrating machinery or object near the camera.

There is no video image in browser

IE browser does not support H5, you need to use VLC plug-in to view videos. Please visit VLC website (<http://www.videolan.org/vlc>) to download and install the 32-bit VLC media player, after installation, the video image will be displayed normally when visit the camera. Other mainstream browsers already support H5 and do not need to install the VLC plug-in.

Unable to access through the browser

- 1) Using PC to access the network to test that the network access can work properly to eliminate the network fault caused by cable and PC virus until the PC and camera can ping each other.
- 11) Disconnect the network, connect camera with PC separately and reset the IP address of PC if necessary.
- 12) Check that the IP address, subnet mask and gateway settings is correct.
- 5) Check that the MAC address is conflicts.
- 6) Check that the web port is modified, the default setting is 80.

Forget the IP address or login password

The default IP address is: 192.168.100.88; the default username and password are: admin.

Control

Remote control does not work

- 1) Check and replace with new batteries.
- 7) Check that the camera is in normal working mode.
- 8) Check the address key of remote control can match the camera.

Serial port cannot control

- 1) Check the protocol, address and bit rate of the camera are consistent.
- 13) Check the control cable is properly connected.



079.79.1101145_V1.1