

# Spatii mari

## Catalog

---

Gama de ecrane de proiectie mari



**SCREENLINE**  
the screen makes the difference

# Spatiu mare

Screenline oferă o gamă largă de ecrane mari.  
Ecranele motorizate pot ajunge la 12 m.  
Gama de cadre, datorită sistemului modular, nu are limite de mărime.

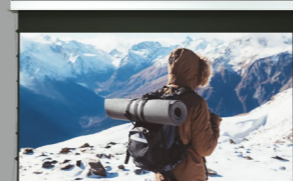
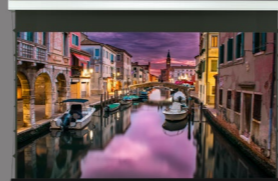
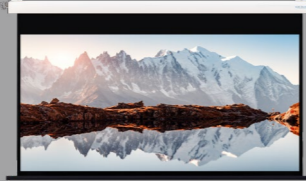

Maximilian  
2.0 standard

Maximilian  
2.0 pro

Lodo  
Evolution  
Lodo Evolution  
tensioned

Big Lodo  
Evolution  
Big Lodo  
tensioned Evo

Lodo  
Inceiling  
Lodo Inceiling  
tensioned

Inceiling  
Big Lodo

New Big  
Frame

New Only  
White

Vertical

Baza de la  
800 până la  
1200 cm.

Baza de la  
800 până la  
1200 cm.

Baza de la  
400 până la  
700 cm.

Baza de la  
700 până la  
850 cm.

Baza de la  
400 până la  
700 cm.

Base from  
700 up to  
850 cm.

Baza de la  
450 până la  
1600 cm.

Baza de la  
450 până la  
1600 cm.

Pentru ecrane  
de până la  
700 cm.

# Maximilian 2.0 standard

Cel mai mare ecran



Baza de la 800 până la 1200 cm.



Panza



Dual face



Home vision



Coral



Perforated



White Ice

## Sistemul Polichinelle

În cazul sistemului "Polichinelle", tubul de înfășurare coboară până la cursa finală inferioară, în timp ce se desfășoară țesătura de proiecție până când aceasta este complet deschisă. Sistemul utilizează două cabluri laterale pentru a pune tubul în mișcare. La ecranul nostru, cele două cabluri sunt înlocuite de două benzi din oțel inoxidabil care, la înfășurare, evită orice posibilă suprapunere sau deraiere.



## Caracteristici cheie

- Ecran motorizat cu sistem "polichinelle"
- Tubul de înfășurare coboară datorită celor 4 tuburi inoxidabile.
- Curele din oțel inoxidabil cu blocuri de siguranță la cele două extremități
- Motor lateral cu transmitere a mișcării prin intermediul axelor rotative
- Carcasă neagră



## Asamblarea ecranului

- Screenline oferă servicii de transport și asamblare a ecranului. Vom împacheta ecranul în pachete cu dimensiuni congruente cu spațiul disponibil pentru accesul în teatru și îl vom monta la fața locului.
- Echipa noastră îl va livra asamblat în poziția corectă pentru a finaliza instalarea.



## Suporturi

Suporturi de ridicare a șuruburilor de ancorare

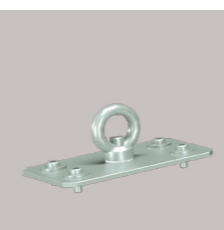

Suporturi de montare pe tavan

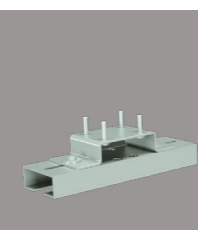

Suporturi de montare pe tavan înalt



Suporturi de montare pe grindă

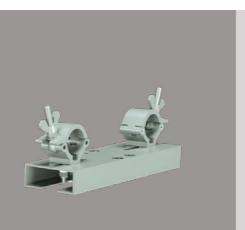

Lanțuri de ridicare



## Noua versiune îmbunătățită

- Gata cu joncțiunile: tub de rulare dintr-o singură bucată
- 15% mai ușor decât versiunile anterioare
- Viteză dublă de 0,50 m/s datorită noului motor: 70 -120 rpm
- Înlocuirea cablurilor de oțel cu curele de oțel: mai silențioase și mai sigure.
- Motor nou cu sistem de siguranță suplimentar. Instalată pe partea dorită.
- Cutia de control furnizată deconectată (fișă rapidă - în sistemul de la bord)

## Instalare ușoară

Grinda de susținere din aluminiu din partea superioară a ecranului conține patru plăci glisante care permit instalarea ecranului cu cleme și suporturi adecvate pentru grinzi din beton, oțel sau lemn.

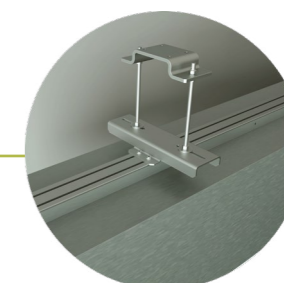

# Maximilian 2.0 pro

Cel mai mare ecran



Baza de la 800 până la 1200 cm.



Panza



Dual face



Home vision



Coral



Perforated



White Ice



## Caracteristici cheie

- Ecran motorizat cu sistem "polichinelle"
- Tubul de înfășurare coboară datorită celor 4 tuburi inoxidabile.
- Curele din oțel inoxidabil cu blocuri de siguranță la cele două extremități
- Motor lateral cu transmitere a mișcării prin intermediul axelor rotative
- Carcasă neagră



## Versiunea Pro

- Curele duble din oțel



## Asamblarea ecranului

- Screenline oferă servicii de transport și asamblare a ecranului. Vom împacheta ecranul în pachete cu dimensiuni congruente cu spațiul disponibil pentru accesul în teatru și îl vom monta la fața locului.
- Echipa noastră îl va livra asamblat în poziția corectă pentru a finaliza instalarea.

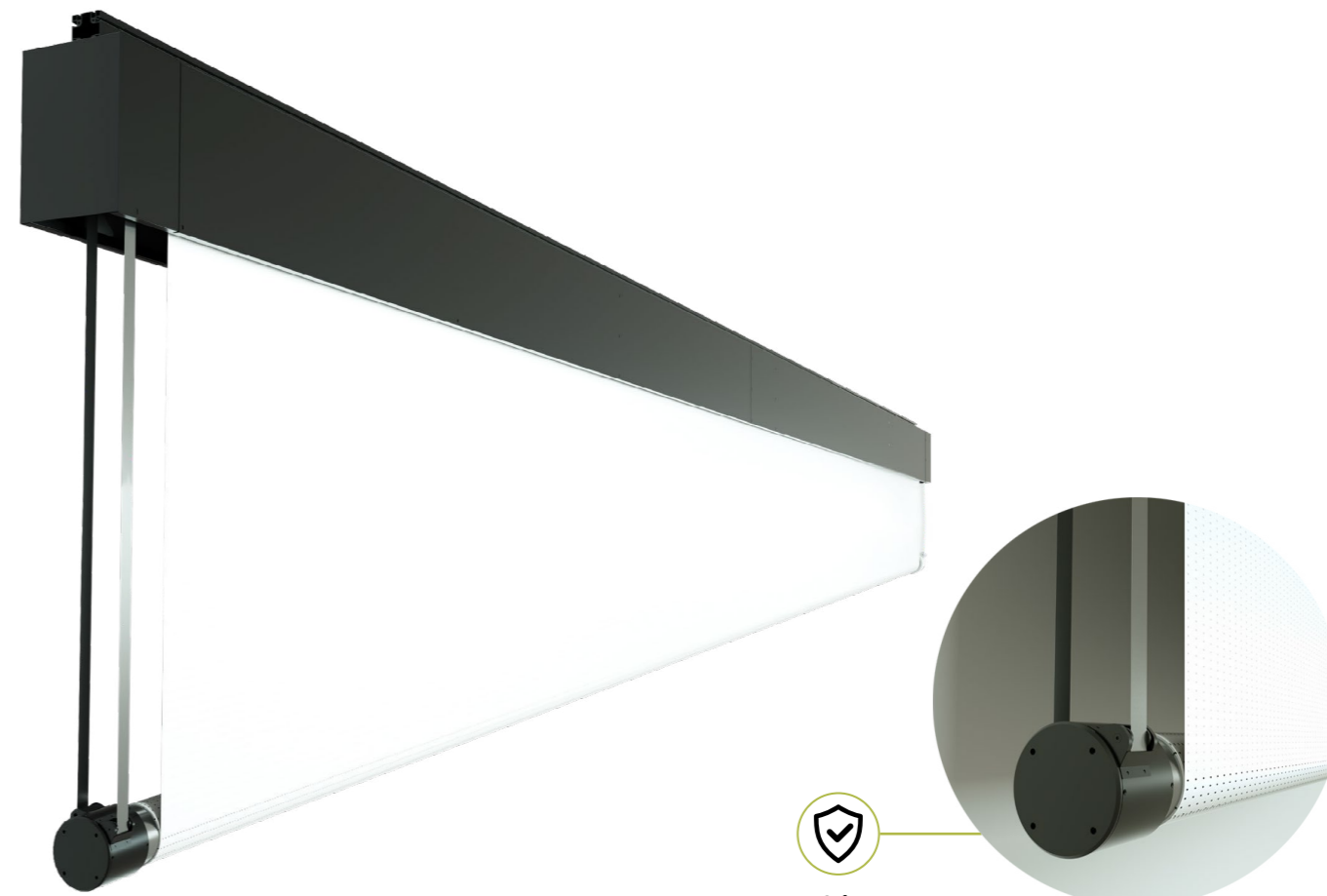

Safer

## Suporturi

Suporturi de ridicare a șuruburilor de ancorare



Suporturi de montare pe tavan

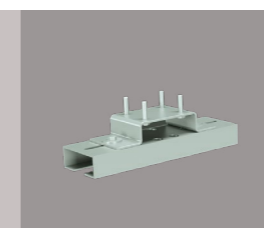

Suporturi de montare pe tavan înalt



Suporturi de montare pe grindă

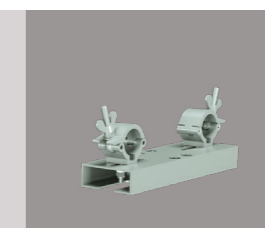

Lanțuri de ridicare

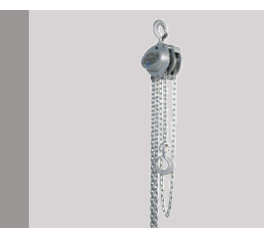

## Funcții

- Gata cu joncțiunile: tub de rulare dintr-o singură bucată
- 15% mai ușor decât versiunile anterioare
- Viteză dublă de 0,50 m/s datorită noului motor: 70 -120 rpm
- Înlocuirea cablurilor de oțel cu curele de oțel: mai calmă și mai sigură.
- Motor nou cu sistem de siguranță suplimentar, instalat pe partea dorită.
- Cutia de control furnizată deconectată (fișă rapidă - în sistemul de la bord)

## Instalare ușoară

- Grinda de susținere din aluminiu din partea superioară a ecranului conține patru plăci glisante care permit instalarea ecranului cu cleme și suporturi adecvate pentru grinzi din beton, oțel sau lemn.

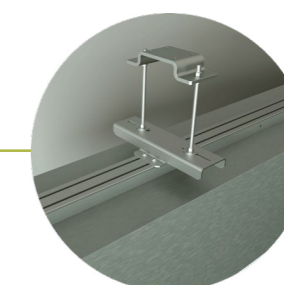

# Lodo Evolution

## Lodo Tensioned Evolution

Ecranul profesional de mari dimensiuni.

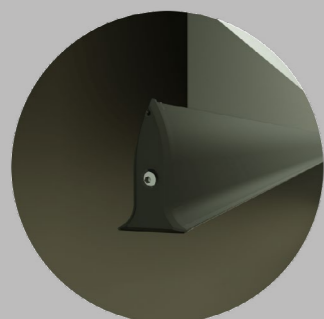

Negru



Alb



Baza de la 400 până la 700 cm.



THEATRE



WORSHIP



CORPORATE



EDUCATIONAL



MUSEUM

Panza



Home vision



Coral



Perforated



White Ice



### Caracteristici cheie

- Pentru spații mari
- Integrarea perfectă a contragreutății în cutie pe termen lung.
- Motor lateral cu transmitere a mișcării prin axul rotativ
- Țesătură anti - cădere.



### Funcții

- Lodo este atât robust și practic: mecanismul realizat din componente robuste din aluminiu permite instalarea de țesături. Larg la bază.
- Suporturile permit instalarea pe perete sau pe tavan, alegerea distanței ecranului față de perete și fac posibilă corectarea poziției centrale și după instalare.



Lodo Evolution

Lodo Evolution Tensioned

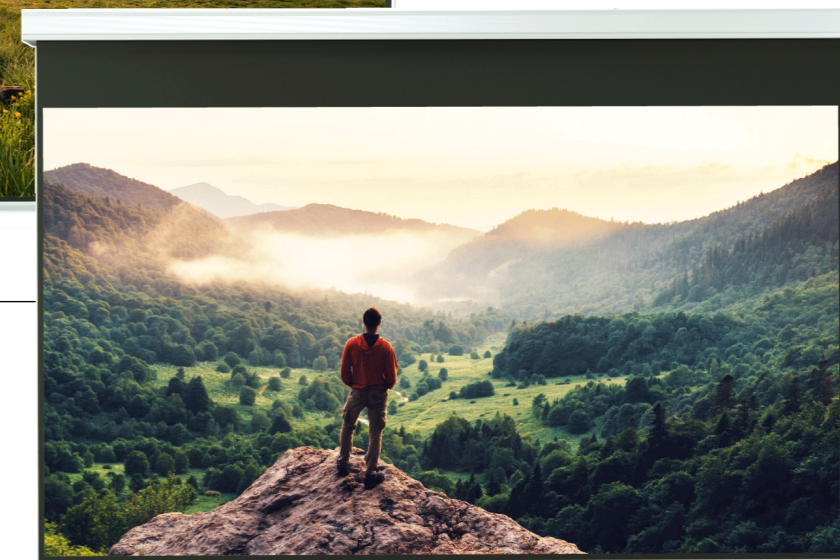

### Suporturi

Pentru instalare pe perete și tavan

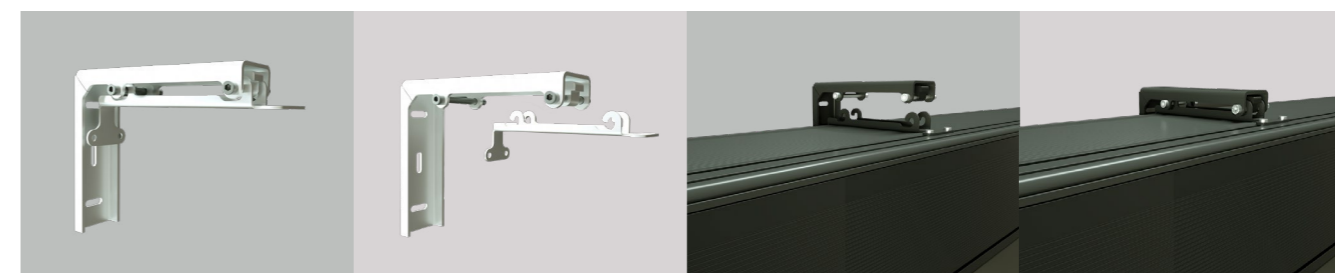

### Motor tubular

- Măsurarea inteligentă a forței.
- Blocare automată atunci când contragreutatea este blocată.
- Întrerupătoarele de limită sunt setate din fabrică, garantând o durată de viață lungă.

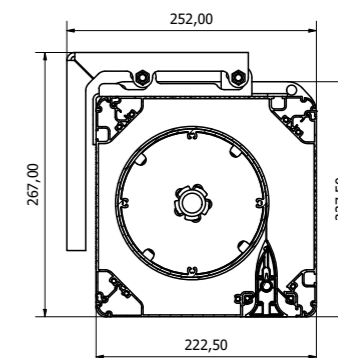

# Big Lodo Evolution

## Big Lodo Tensioned Evo

Ecranul profesional de mari dimensiuni.



Baza de la 700 până la 850 cm.



THEATRE



WORSHIP



CORPORATE



EDUCATIONAL



MUSEUM

Panza



Home vision



Coral



Perforated



White Ice



### Caracteristici cheie

- Pentru spații mari
- Integrarea perfectă a contragreutății în cutie pe termen lung.
- Țesătură anti - cădere.
- Disponibil în alb sau negru



### Funcții

Lodo este atât robust și practic: mecanismul realizat din componente robuste din aluminiu permite instalarea de țesături largi la bază.

Suporturile permit instalarea pe perete sau pe tavan, alegerea distanței ecranului față de perete și fac posibilă corectarea poziției centrale și după instalare. Lanțurile facilitează ridicarea și deplasarea ecranului. Odată ancorate, acestea reprezintă o măsură suplimentară de siguranță.

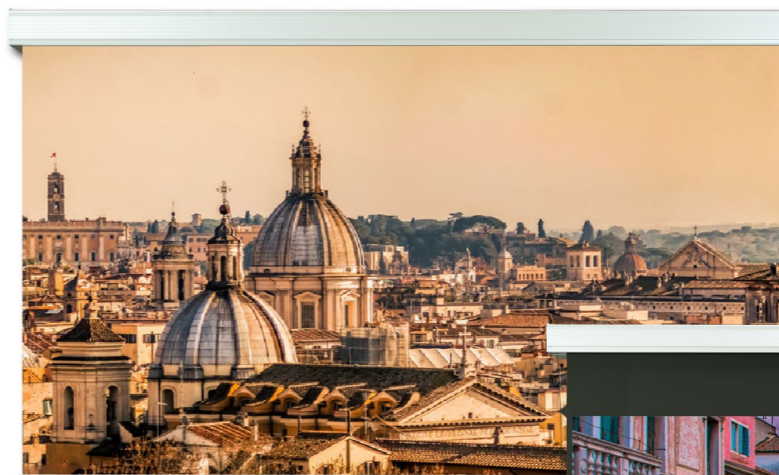

Big Lodo Evolution

Big Lodo Evolution Tensioned

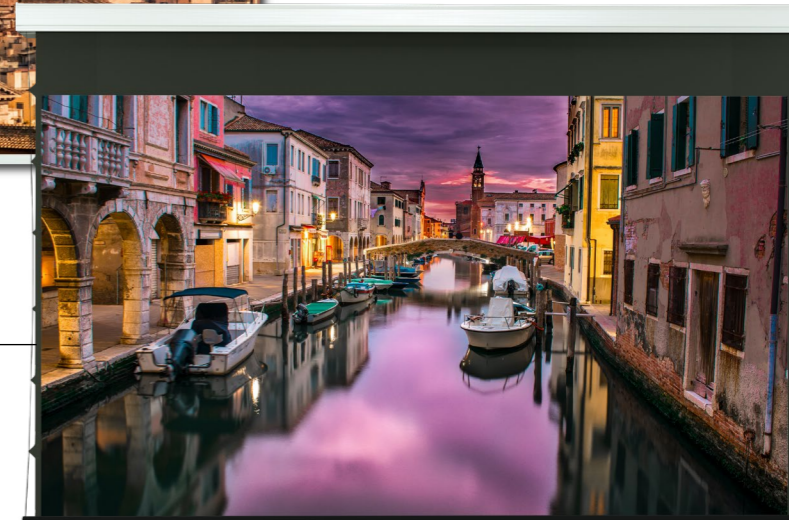

### Suporturi

Pentru instalare pe perete și tavan

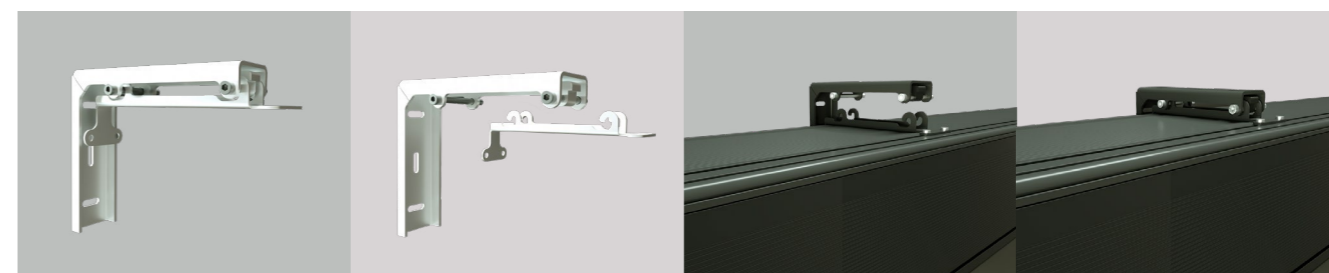

### Motor tubular

- Măsurare inteligentă a forței.
- Blocare automată atunci când contragreutatea este blocată.
- Întrerupătoarele de capăt sunt setate din fabrică, garantând o durată de viață lungă.

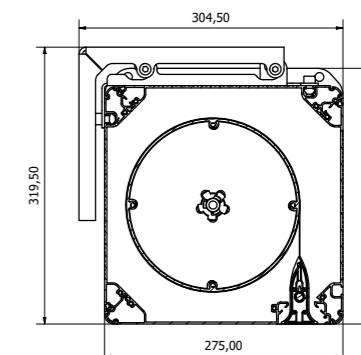

# Lodo Inceiling

# Lodo Inceiling Tensioned

Ecran încastrat motorizat.



Baza de la 400 până la 700 cm.



THEATRE



WORSHIP



CORPORATE



EDUCATIONAL



MUSEUM

Panza



Home vision



Coral



Perforated



White Ice



## Caracteristici cheie

- Pentru spații mari
- Integrarea perfectă a contragreutății în cutie pe termen lung.
- Țesătură anti - cădere..



## Funcții

- Finisaj îngrijit, complet închis.
- Bara cu greutate are o bază plată care se așează complet la același nivel cu carcasa ecranului pentru un aspect estetic frumos atunci când ecranul este închis.

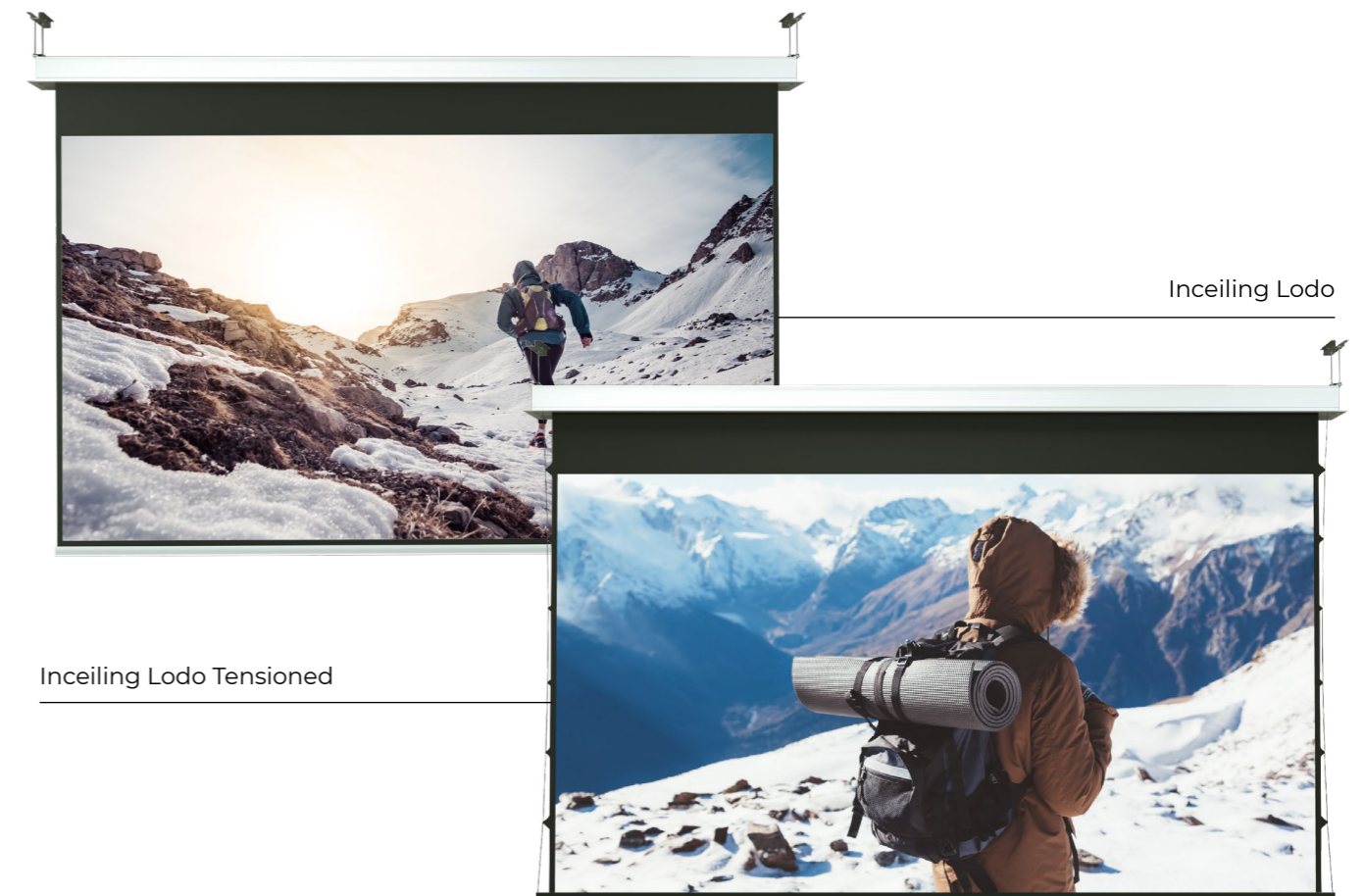

Inceiling Lodo

Inceiling Lodo Tensioned



## Motor tubular

- Măsurare inteligentă a forței.
- Blocare automată atunci când contragreutatea este blocată.
- Întrerupătoarele de capăt sunt setate din fabrică, garantând o durată de viață lungă.

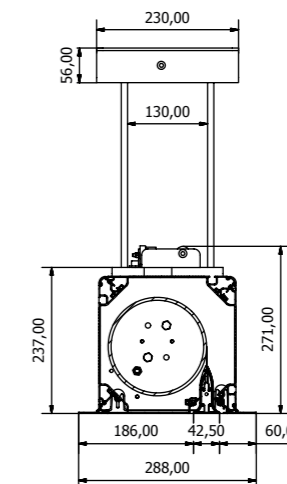

# Big Lodo Inceiling

# Big Lodo Inceiling Tensioned

Ecran încastrat motorizat.

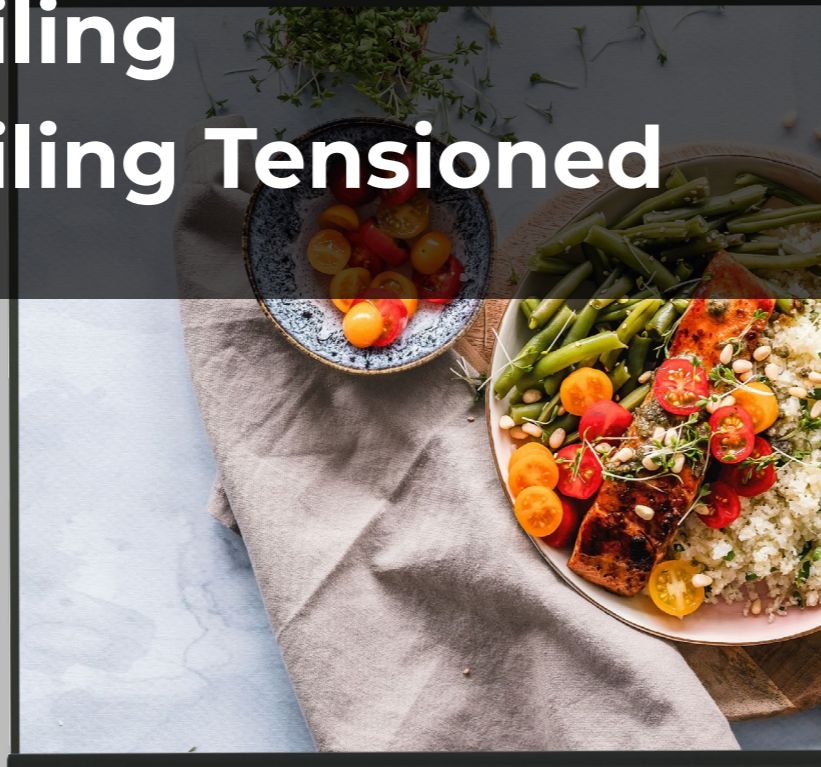

Baza de la 700 până la 850 cm.



Panza



Home vision

Coral

Perforated

White Ice



## Caracteristici cheie

- Pentru spații mari
- Integrarea perfectă a contragreutății în cutie pe termen lung.
- Țesătură anti - cădere.



## Functii

- Finisaj îngrijit, complet închis.
- Bara cu greutate are o bază plată care se așează complet la același nivel cu carcasa ecranului pentru un aspect estetic frumos atunci când ecranul este închis.

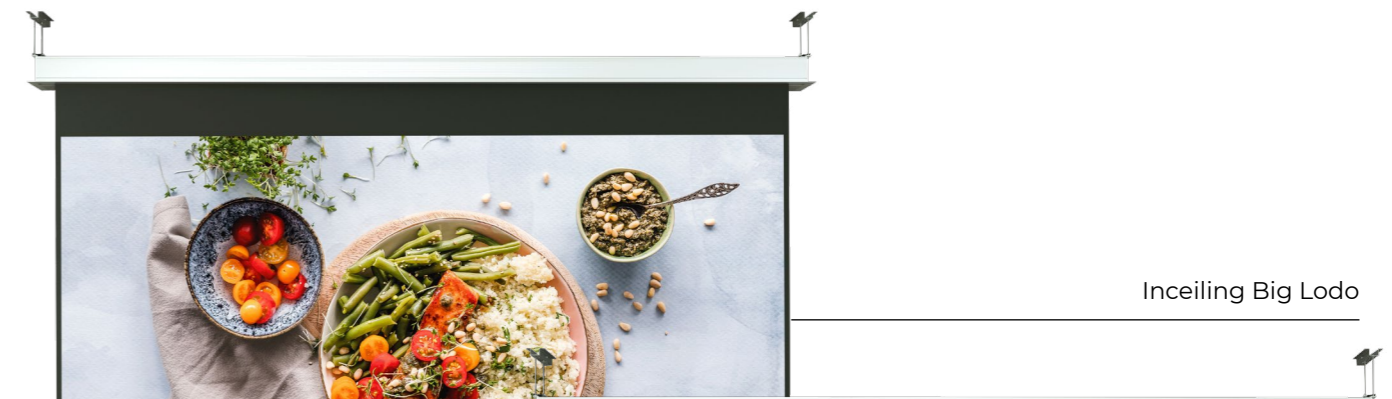

Inceiling Big Lodo

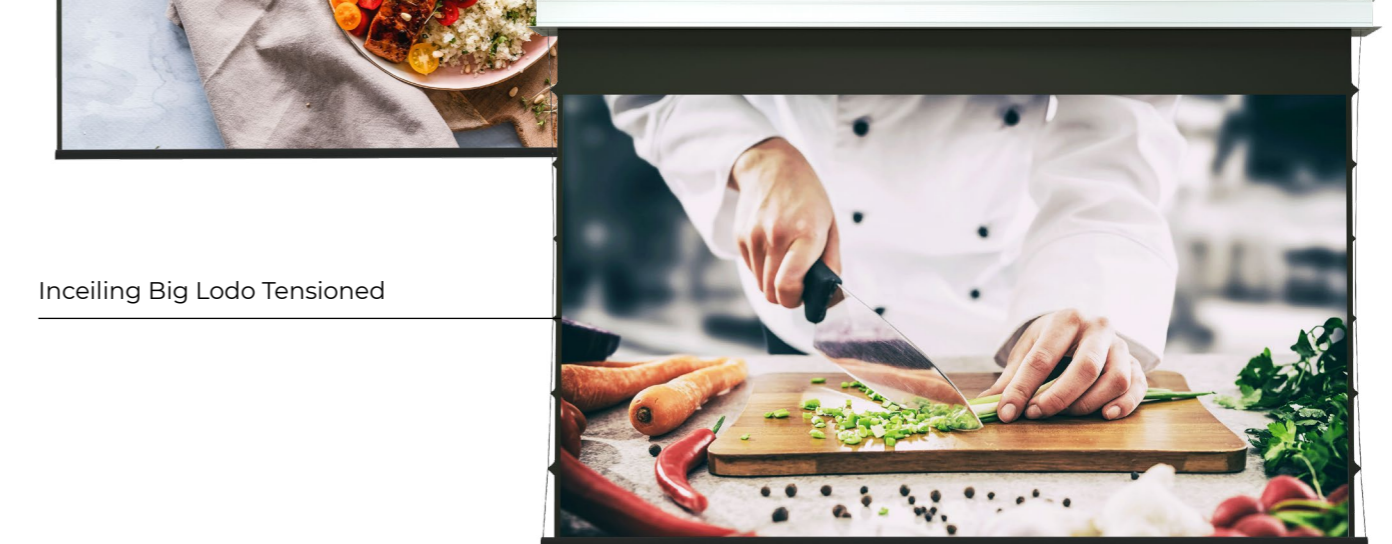

Inceiling Big Lodo Tensioned

## Suporturi

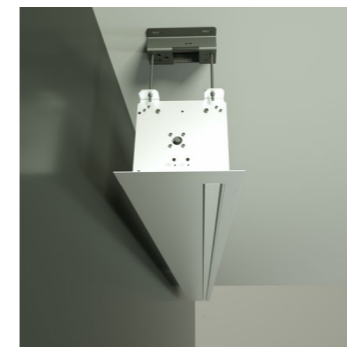

## Motor tubular

- Măsurarea inteligentă a forței.
- Blocare automată atunci când contragreutatea este blocată.
- Frână silențioasă.
- Înterupătoarele de capăt sunt setate din fabrică, garantând o durată de viață lungă.

## Desen tehnic

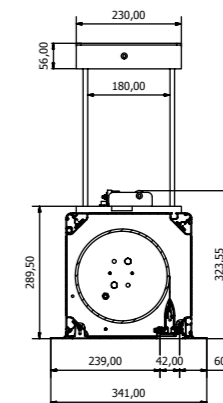



# New Big Frame

Pentru spații mari



Baza de la 450 cm până la 1600 cm  
Datorită sistemului modular, New Big Frame poate ajunge la peste 40 m.



THEATRE  
WORSHIP  
CORPORATE  
EDUCATIONAL  
MUSEUM

Panza



**D**iamond **M**icroperforated **P**erforated **Df** Dual face **A**mbră  
4K 4K 4K 4K 4K



## Caracteristici cheie

- Pentru spații mari
- Instalare ușoară și rapidă a țesăturii cu margine de săgeată de presiune
- Cadru robust
- Diverse accesorii de fixare
- Extrem de versatil în multe utilizări
- Disponibil și cu sistem de pini



## Funcții

- Rapid:** Cadru nou cu margini cu săgeți. Se instalează cu ușurință datorită țesăturii de fixare prin decupare poziționată în interiorul canelurii dedicate, înlocuind instalarea lentă a vechilor rame cu ochiuri.
- Inteligent:** 5 caneluri de fixare permit adaptarea la întinderea și contracția țesăturii.
- Curat:** Nu mai există pete sau abraziuni pe țesătură. Acum, plasarea țesăturii este făcută cu fața în sus.



## Sistem modular

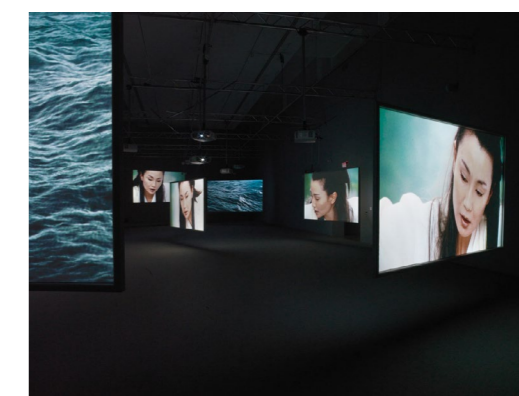
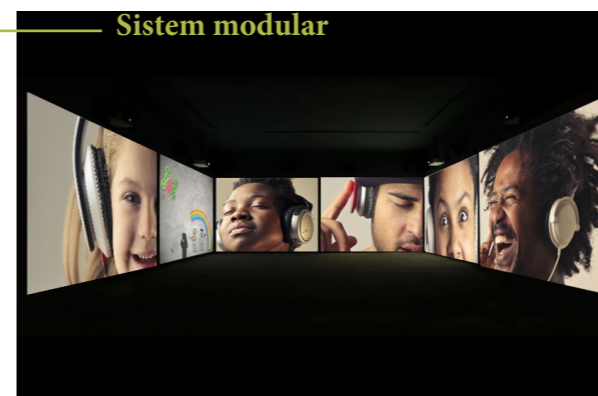

## Suporturi



## Standuri



## Suruburi

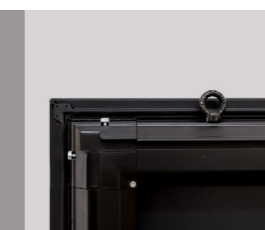

## Cleme Aliscaf



## Picioare

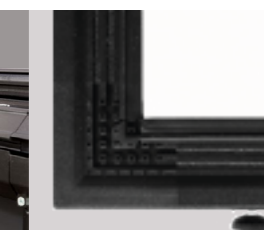

## Instalarea țesăturii cu margini de săgeată de presiune



# Nou Numai alb

Viziune completă



Instalare ușoară



Baza de la 450 cm până la 1600 cm -  
Datorită sistemului modular, New Big Frame poate ajunge la peste 40 m.



THEATRE



WORSHIP



CORPORATE



EDUCATIONAL



MUSEUM

## Panza



Diamond

Microperforated

Perforated

Dual face

Ambr



## Caracteristici cheie

Pur și simplu alb, perfect plat și curat, New Only White se remarcă prin eleganță și armonie în orice aplicație, satisfăcând cerințele și gusturile celui mai exigent client.

New Only White are aceeași ramă ca și New Big Frame: Rama în sine oferă o viziune completă. Prin simpla fixare a unei țesături mai mari în canelura posterioară a cadrului obținem un ecran perfect plat, complet alb, de dimensiuni remarcabile.

Instalarea rapidă și curată rămâne o prerogativă absolută a acestui nou ecran, chiar dacă principala sa calitate este frumusețea.



## Sistem versatil / modular

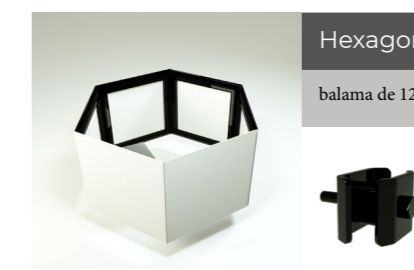

# Vertikal

Ecran cu ridicare



Poate ridica ecrane de la o suprafață de vizualizare de 300 cm până la 700 cm.



## Caracteristici cheie

Lift pentru ecrane de până la 7 metri de suprafață de vizualizare. Sistem modular cu 2 tamburi. Înălțime maximă de 500 cm. Motor tubular cu frână electromecanică integrată.



## Disponibil pentru

- MOT
- JAGO
- COPERNICO
- LODO
- LODO EVOLUTION



## Caracteristici tehnice

- 3 puncte de ancorare
- 2 curele de oțel
- Înălțimea maximă a curelelor de oțel: 5m



Înălțime maximă 500 cm

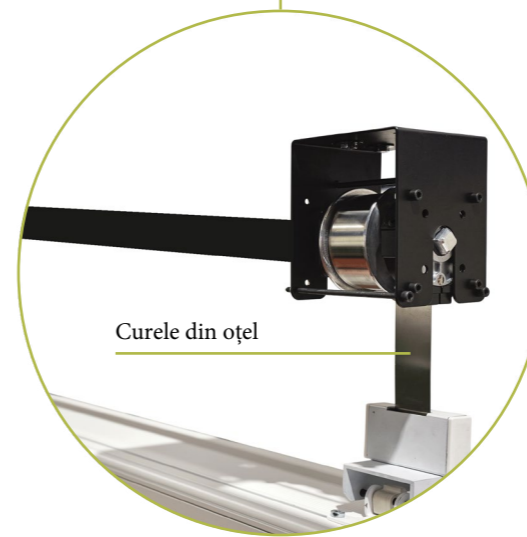

Curele din oțel

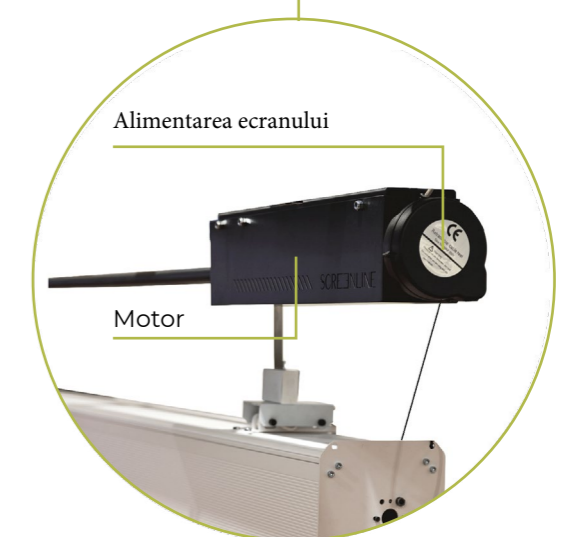

Alimentarea ecranului

Motor

## Versatile / modular system

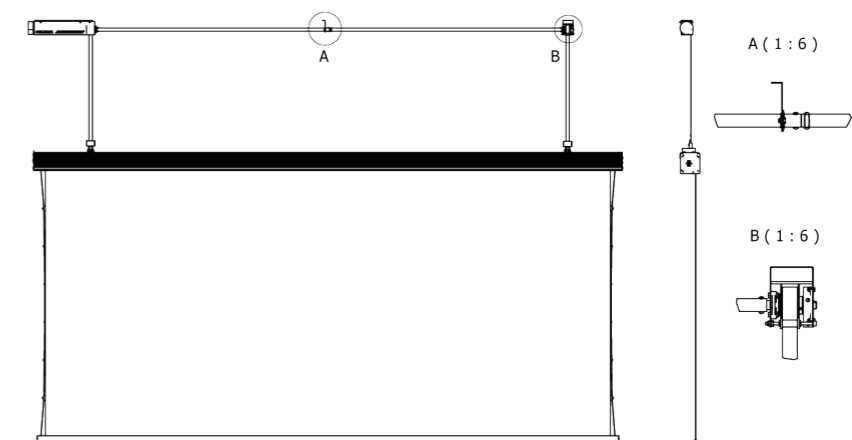





## Screenline S.R.L

📍 38060 Besenello (TN)  
Via Nazionale, 1/n - 1/u

☎ +39 0464 830003

✉ info@screenline.it

🌐 www.screenline.it

**SCREENLINE**  
the screen makes the difference

Designeri și producători de ecrane din Italia

