

DALI SOUND HUB

HDMI module • NPM BluOS module

MANUAL



IN ADMIRATION OF MUSIC

Contents

1. SOUND HUB Overview	4	6. Trouble-Shooting and Maintaining Your SOUND HUB	32
2. Unpacking	9	6.1 Cleaning	32
3. Installation and Setup	10	6.2 Wireless Connection Channel Options	33
3.1 Location	10	6.3 Reset to Defaults	35
3.2 Getting Started and Switching On	11	6.4 Firmware Update	36
3.3 Connecting Speakers	12	6.5 Disposal	37
3.4 Connecting an External Power Amplifier	16	7. Installing and Using the SOUND HUB NPM BluOS Module	38
4. Connecting Audio Sources	17	7.1 Installation	39
4.1 Bluetooth Audio	17	7.2 Network Connection	41
4.2 Wired Audio	19	7.3 Using Your NPM equipped SOUND HUB	44
4.3 Connecting Network Audio Streams	20	7.4 NPM Reset to Defaults	45
5. Using Your SOUND HUB	21	8. Installing and Using the SOUND HUB HDMI Module	46
5.1 Standby	21	8.1 Installation	48
5.2 Volume	22	8.2 Configuring Your HDMI Equipped SOUND HUB	50
5.3 Mute	23	8.3 Using Your HDMI Equipped SOUND HUB	54
5.4 Source Selection	24	9. Technical Specifications	58
5.5 Auto Signal Sensing	25	10. Diagrams / Tables	59
5.6 Display and Indicator Illumination	26		
5.7 Speaker Balance Adjustment	27		
5.8 Speaker Distance Adjustment	29		



Introduction

Thank you for choosing the DALI SOUND HUB. DALI is renowned throughout the world for continually striving to enhance the experience of music while simultaneously designing audio products that better suit our lives and homes. The DALI SOUND HUB wireless streaming preamplifier is the latest expression of those twin aspirations.

The DALI SOUND HUB is a technologically advanced product that requires thoughtful installation. We recommend therefore that you read this manual carefully, and follow its advice, when installing your DALI SOUND HUB.

Following this introduction the manual covers unpacking, installation, setup, connections and use, and also includes sections that describe installation and use of the optional BluOS NPM and HDMI modules. The manual begins with a short overview of the DALI SOUND HUB.



1. SOUND HUB Overview

The DALI SOUND HUB is a control preamplifier and source selection hub for DALI wireless speaker systems such as the OBERON C, CALLISTO C and RUBICON C series.

The DALI SOUND HUB takes both wired audio sources and wireless audio streams and broadcasts them wirelessly to connected active speakers.

The SOUND HUB has five wired audio inputs and can also connect to Bluetooth audio devices. The wired inputs comprise analogue mini-jack and RCA phono sockets, a coaxial digital input, and two TOSLINK optical digital sockets. SOUND HUB Bluetooth is compatible with the SBC, AAC, aptX and aptX HD audio streaming formats. In addition to its wireless speaker connections, the SOUND HUB is fitted with mono subwoofer and stereo preamplifier outputs.

The input and output capabilities of the DALI SOUND HUB can be expanded by the installation of one or two optional modules:

The NPM-1 and NPM-2i modules employ the BluOS streaming platform to enable the SOUND HUB to play audio from a range of network streaming services, music libraries, internet radio and USB storage. The NPM-2i module differs

from the NPM-1 module by incorporating Apple Airplay 2 streaming technology. Installation and use of an NPM module is described and illustrated in [Section 7 / page 38](#).

The HDMI module adds an input for HDMI ARC or HDMI eARC equipped TVs and incorporates Dolby Digital and DTS decoding to enable the SOUND HUB to broadcast to multi-channel speaker systems. Installation and use of the HDMI module is described and illustrated in [Section 8 / page 46](#).

HDMI eARC (sometimes referred to as HDMI 2.X) is a technology that enables far higher quality audio performance than HDMI ARC. In particular, eARC is able to transmit up to 8 channels of uncompressed, high-resolution audio from a TV to audio devices such as a DALI SOUND HUB. If your TV offers both ARC and eARC connection or settings options, always use the eARC option to connect your DALI SOUND HUB.

The SOUND HUB can be controlled using either its front panel controls or the supplied Bluetooth connected remote control. If an NPM module is installed, the SOUND HUB can also be controlled via the BluOS Controller app, and if an HDMI module is fitted a TV remote control can also be used for some functions.



1. SOUND HUB Overview

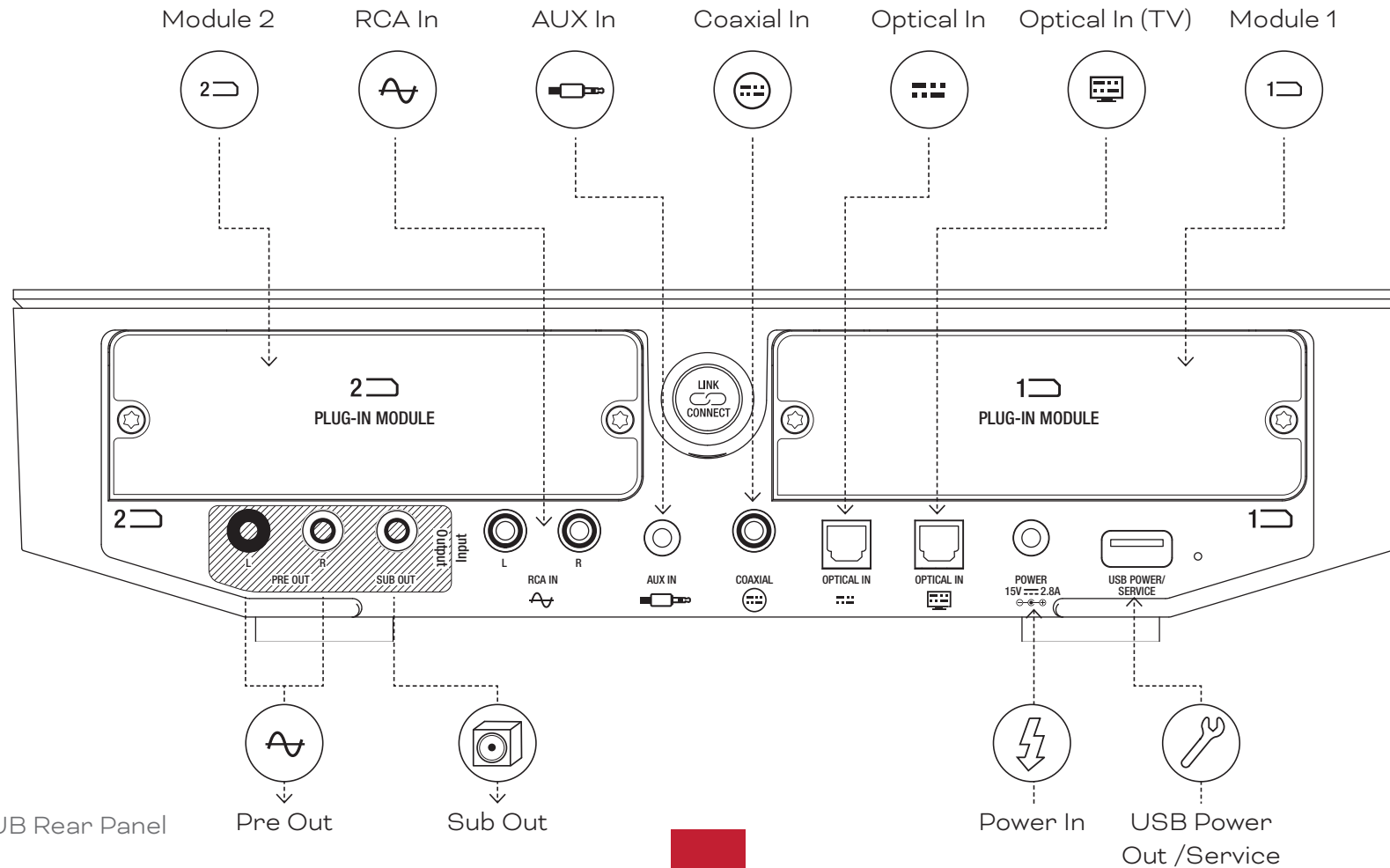

D1: SOUND HUB Rear Panel



IN ADMIRATION OF MUSIC



1. SOUND HUB Overview

D2: SOUND HUB Front Panel

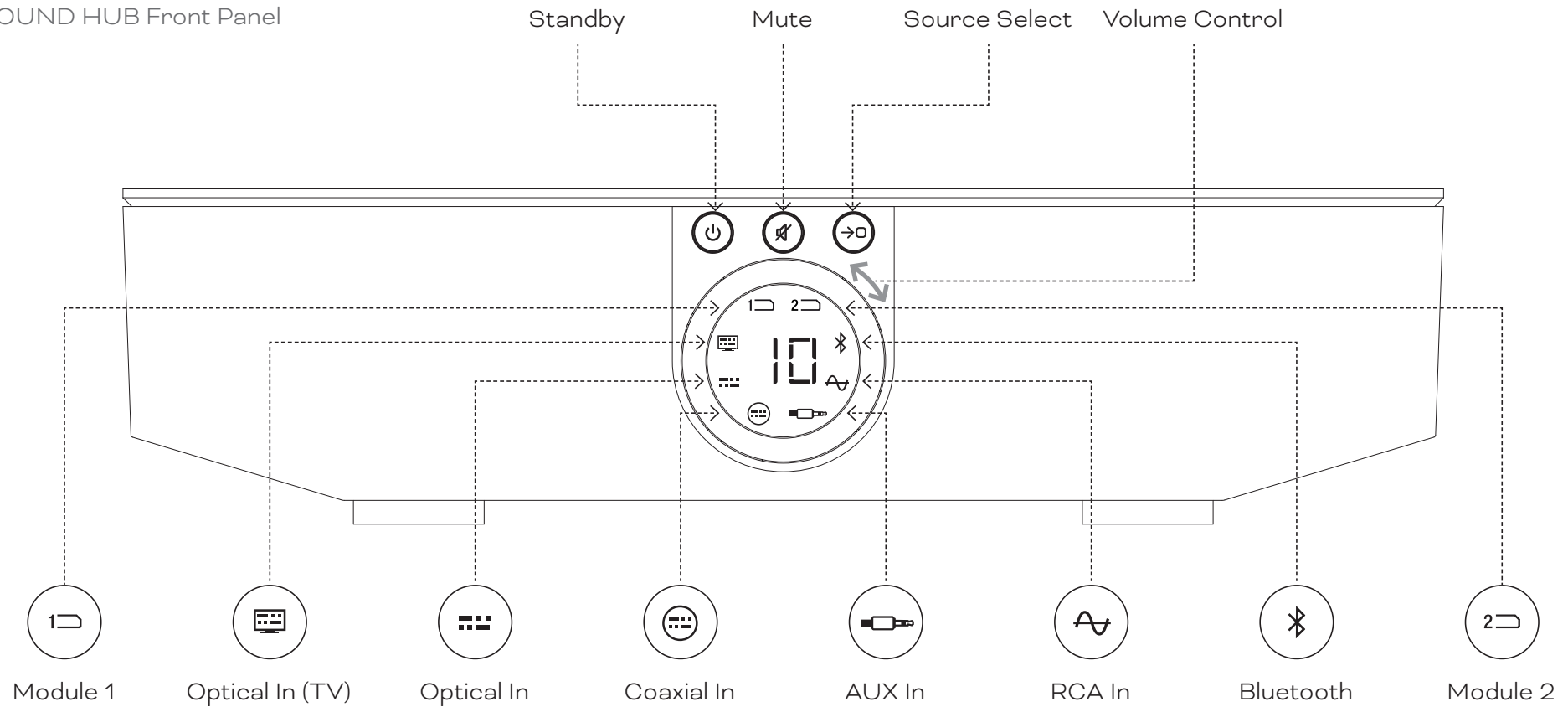

IN ADMIRATION OF MUSIC



1. SOUND HUB Overview

D3: Remote Control

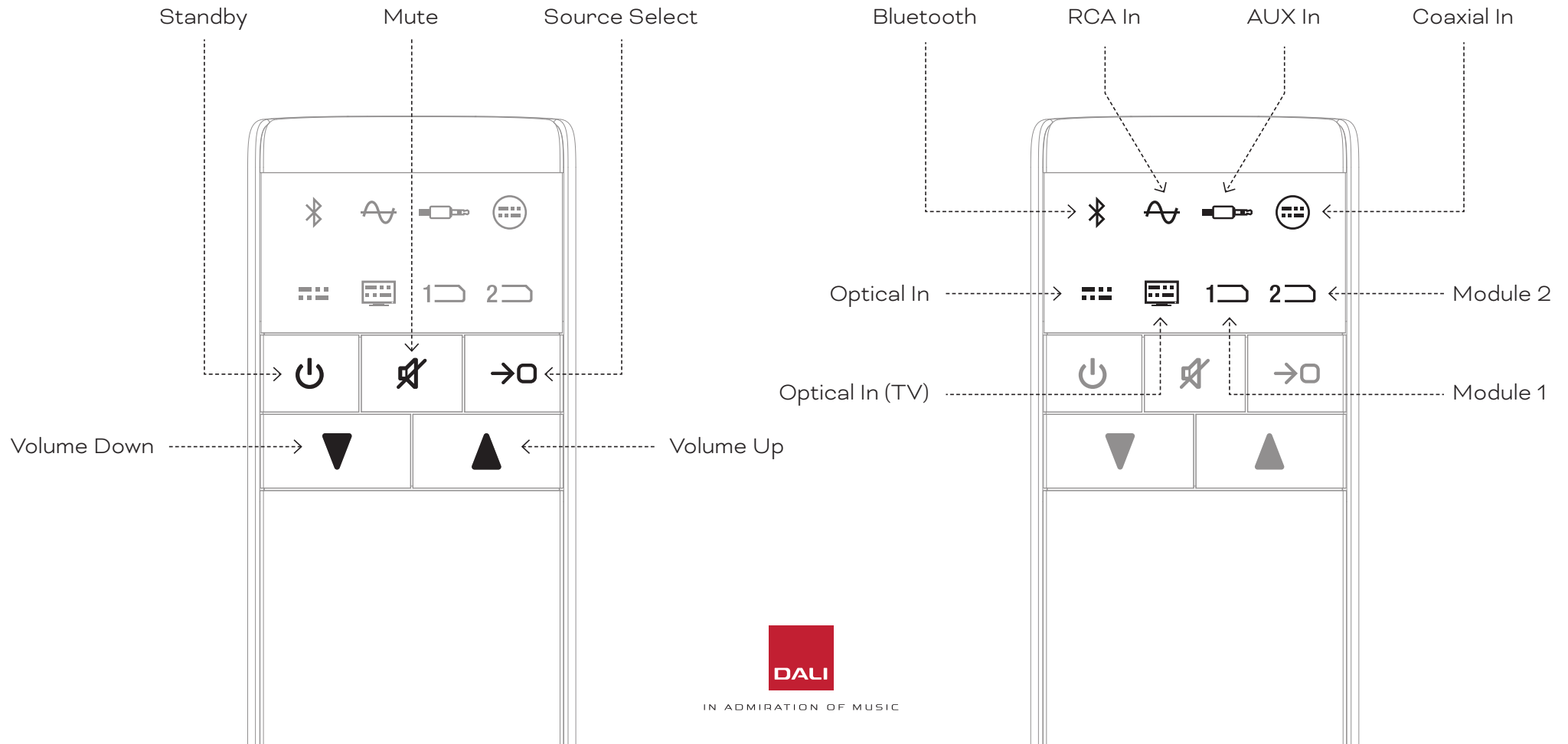

1. SOUND HUB Overview

D 4: Setups

The DALI SOUND HUB can be used with the DALI speakers illustrated below and the DALI Wireless Subwoofer Receiver WSR.

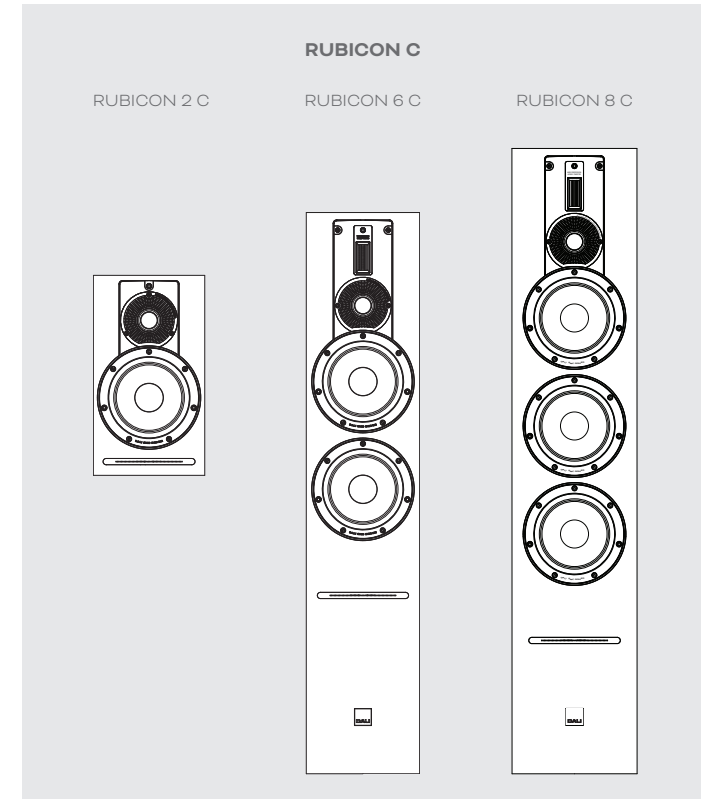
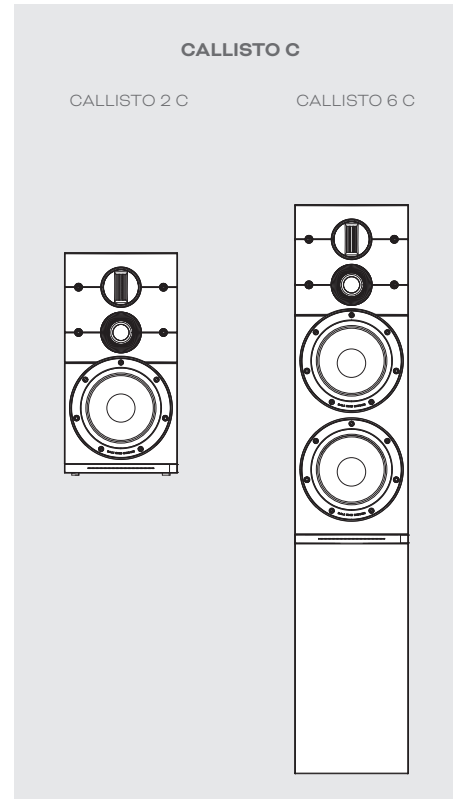
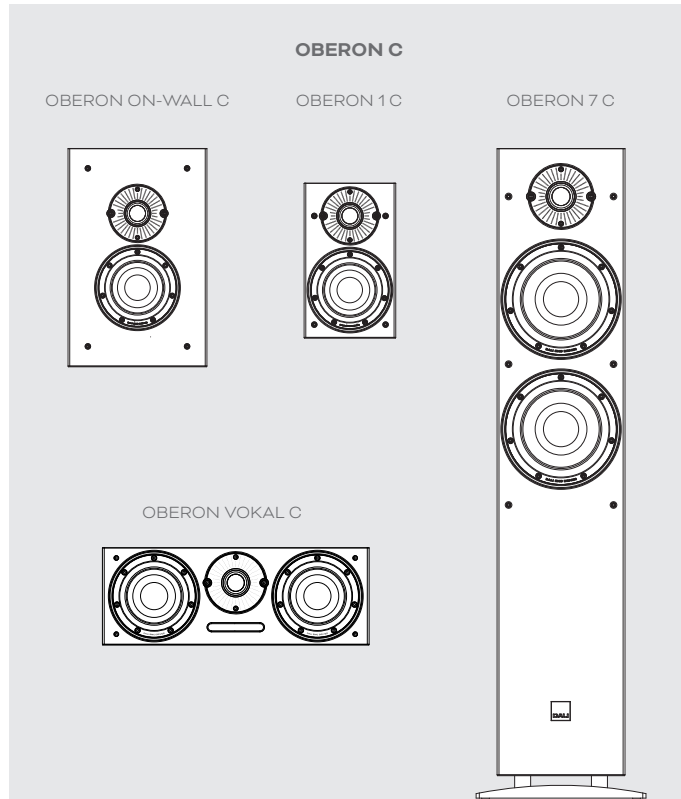

IN ADMIRATION OF MUSIC



2. Unpacking

The contents of the DALI SOUND HUB pack is illustrated in [Diagram D5 / page 9](#) and listed below.

- 1: SOUND HUB
- 2: Power supply with international mains socket adaptors
- 3: Bluetooth remote control and batteries
- 4: Document pack

Take care when unpacking your SOUND HUB. A transparent protection film is applied over the top surface and the front panel display. We recommend that the protection film is left in place until your SOUND HUB is installed in its final location.

NOTE:

We suggest that you retain your SOUND HUB packaging for future use. However, if that is not possible please dispose of it responsibly.

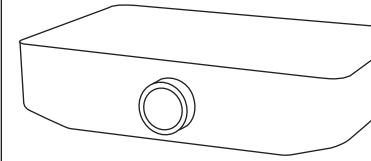
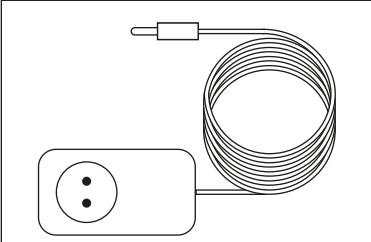
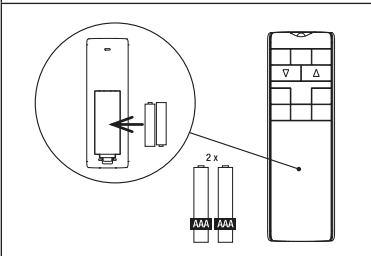
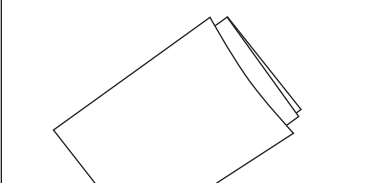
DALI SOUND HUB	
	× 1
	× 4
	× 1
	× 1

D5: In the box

3. Installation and Setup

3.1 Location

Your DALI SOUND HUB can be located predominantly as is convenient, although it should be located within the same room as the speakers it is to be connected to and no more than 10 metres (33 ft) from any of them. We recommend the SOUND HUB is placed on a furniture unit or shelf however the only constraints are accessibility to mains power and to the signal cables for any wired audio sources.

NOTE:

Thanks to its Bluetooth remote control, your SOUND HUB can be placed inside a closed cupboard or otherwise out of sight.

If you intend to fit either or both of the SOUND HUB modules you should do so before the SOUND HUB is in its final position. Refer to [Section 7 / page 38](#) and [Section 8 / page 46](#) for instructions on installing the modules.

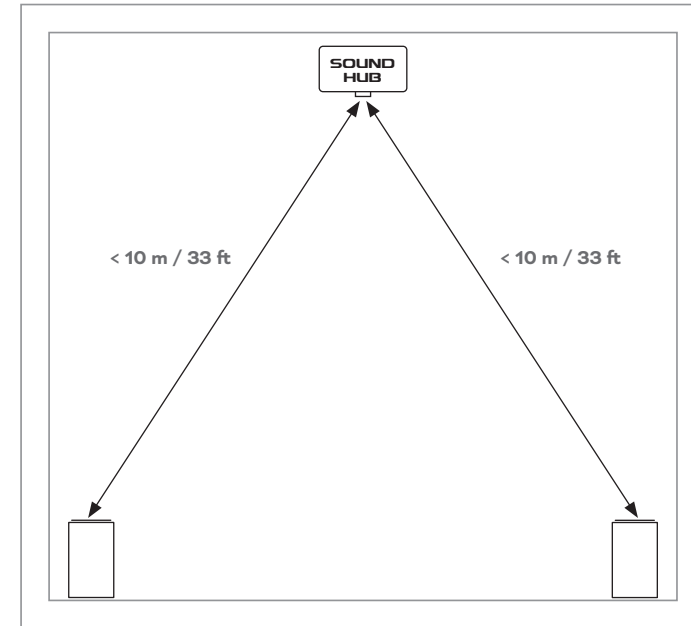

3. Installation and Setup

3.2 Getting Started and Switching On

Begin your DALI SOUND HUB installation process by following the steps below.

- Install batteries in the SOUND HUB remote control. [Diagram D 6 / page 11](#) illustrates battery installation.
- With the location of your SOUND HUB selected and any modules fitted, plug the power supply cable into the rear panel POWER socket illustrated in [Diagram D 1 / page 5](#) and then plug the power supply into an appropriate mains power socket.
- Switch on your SOUND HUB by pressing the front panel Standby button illustrated in [Diagram D 2 / page 6](#). The SOUND HUB remote control will automatically connect via Bluetooth within 30 seconds.

D6: Inserting batteries

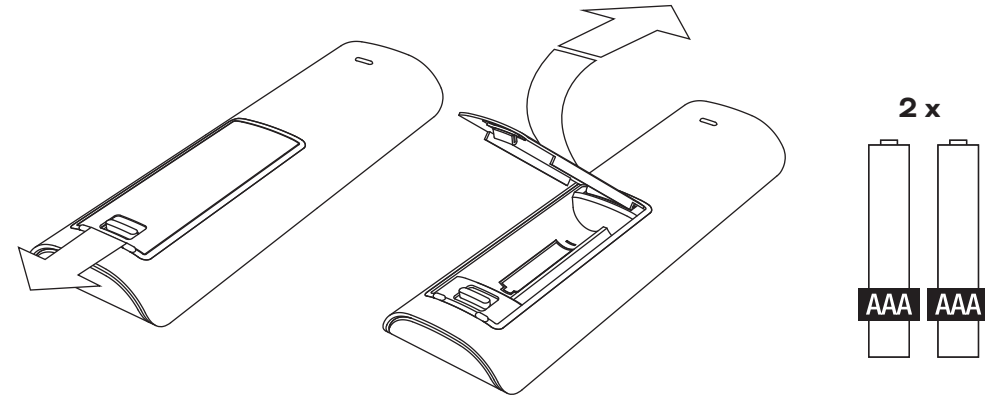

NOTE:

If your SOUND HUB has been previously used it may need to be reset to its defaults.

To reset your SOUND HUB, follow the instructions in [Section 6.3 / page 35](#).

3. Installation and Setup

3.3 Connecting Speakers

If your SOUND HUB has an HDMI module installed, up to seven speaker positions and one subwoofer position can be connected, however the three DALI wireless speaker series (OBERON C, CALLISTO C, RUBICON C) offer some models that are only able to assume specific channel roles. The speakers and roles are specified in the adjacent table.

If your SOUND HUB has no HDMI module installed, it can connect to only stereo left and right speaker positions and a subwoofer. In either case the subwoofer can be connected to the SOUND HUB wired subwoofer output or via a DALI WSR Wireless Subwoofer Receiver.

T1: Speaker channel assignments

Model	Front Left	Front Right	Centre	Side Left	Side Right	Rear Left	Rear Right	Sub
OBERON C	✓	✓	✓	✓	✓	✓	✓	
CALLISTO C	✓	✓		✓	✓	✓	✓	
RUBICON C	✓	✓		✓	✓	✓	✓	
WSR								✓

NOTE:

The way in which your SOUND HUB routes audio to a DALI WSR Wireless Subwoofer Receiver, or to its wired subwoofer output, depends on the type of audio material. If the material is multi-channel encoded and input via a SOUND HUB HDMI module, the subwoofer will play the decoded LFE (Low Frequency Effects) signal. If however the material is conventional stereo, the subwoofer will output an appropriately low-pass filtered component of the signal. In this case, the front left and right speaker output signals will also be appropriately high-pass filtered, depending on the size of the speakers.

Always use the LFE input on the subwoofer when connecting the SOUND HUB or the DALI WSR. If the subwoofer has no LFE input, connect to its standard line input and either switch its low-pass filter to bypass or set its low-pass filter frequency to maximum.



3. Installation and Setup

3.3 Connecting Speakers

To establish the connections between the SOUND HUB and your DALI wireless active speakers and any DALI WSR equipped subwoofer, follow the steps below.

The SOUND HUB speaker connection procedure is illustrated in [Diagram D7 / page 14](#) and [Diagram D8 / page 15](#).

- Check that the speakers and any subwoofer (or DALI WSR Wireless Subwoofer Receiver) to be used are connected to mains power and switched on. Refer to their user manuals to identify their power switch if necessary.
- Press the LINK & CONNECT button on your SOUND HUB. The top panel position display will illuminate and the front panel volume indicator will illuminate cyclically.
- Go to one of the speakers (or the WSR if in use), and press its LINK & CONNECT button. The channel matrix indicator on the speaker rear panel will illuminate cyclically while connection to the SOUND HUB is

underway. When connection is established, the cyclic illumination will stop, leaving the channel matrix indicators flashing slowly. If the SOUND HUB is equipped with an HDMI module, multiple channel indicators will flash. Otherwise, only the stereo left and right indicators will flash, indicating that these are the only channels available. The speaker will play a short confirmation tone.

- With the speaker or WSR connected to the SOUND HUB, it can be assigned to a channel. The channel matrix display incorporates indicators at each channel position, and pressing the speaker LINK & CONNECT button changes the channel assigned to the speaker. Press the LINK & CONNECT button repeatedly until the required channel for the speaker is highlighted.
- Repeat the channel assignment procedure for each speaker or the WSR and when each one is done return to your SOUND HUB. Verify, from continuously illuminated

SOUND HUB top panel indicators that all required channels are assigned. Now press the SOUND HUB rear panel LINK & CONNECT button to complete the speaker connection process. All the speakers will play a short confirmation tone, the SOUND HUB top panel display will switch off, and the front panel indicator will return to volume display.

Once all speakers are connected to your SOUND HUB we recommend that you carry out the Speaker Balance Adjustment ([Section 5.7 / page 27](#)) and Speaker Distance Adjustment ([Section 5.8 / page 29](#)) routines. In addition to enabling balance and distance adjustment, these routines provide a check on speaker and channel assignments.

NOTE:

Setup indication on the WSR is simplified as it only offers one channel option.



3. Installation and Setup

3.3 Connecting Speakers

The SOUND HUB must be switched ON.

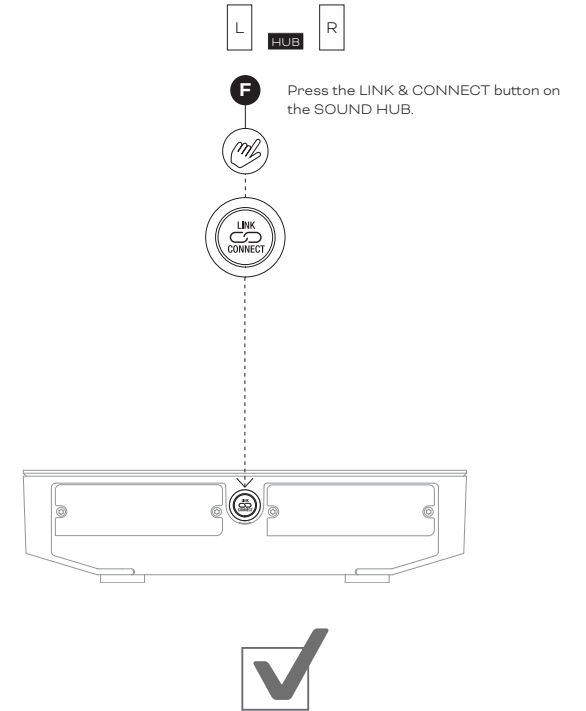
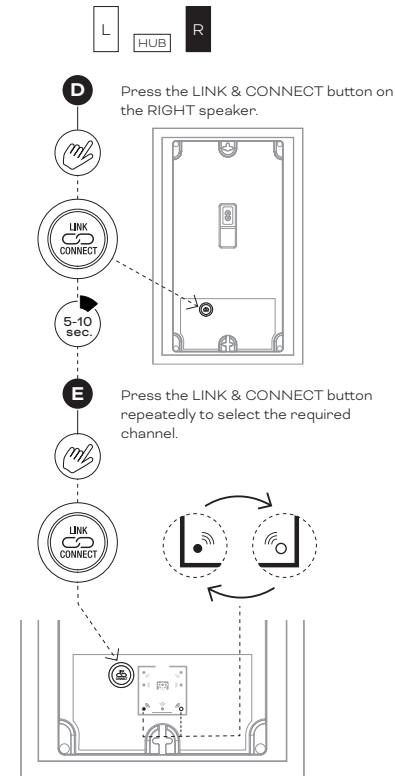
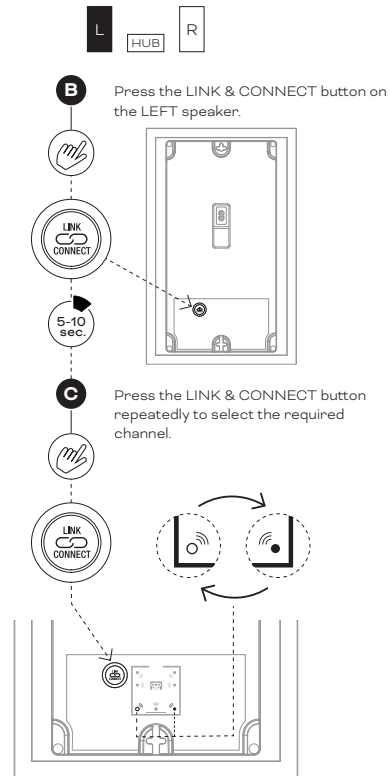
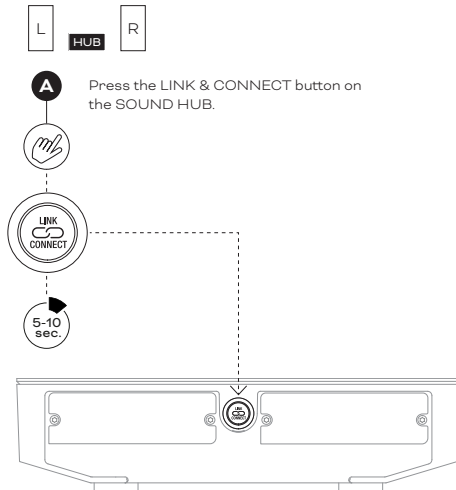

NOTE:

SOUND HUB without HDMI module.



IN ADMIRATION OF MUSIC

D7: Connecting Speakers



3. Installation and Setup

3.3 Connecting Speakers

D 8: Multi-Channel Home Theatre System

The SOUND HUB must be switched ON.

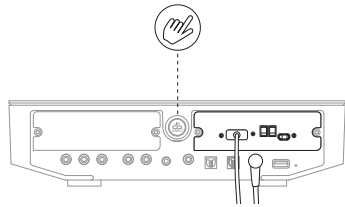

A Press the LINK & CONNECT button on the SOUND HUB.

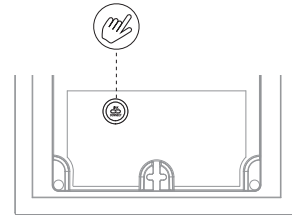

B Press the LINK & CONNECT button on the first speaker.



C Press the LINK & CONNECT button repeatedly if necessary to select the required channel.

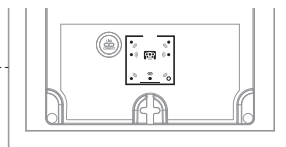
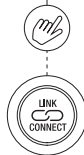

D Repeat procedure for each speaker.

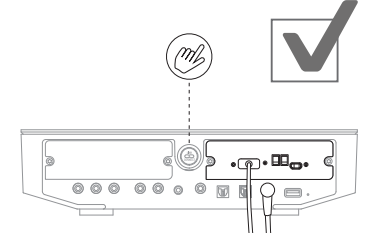
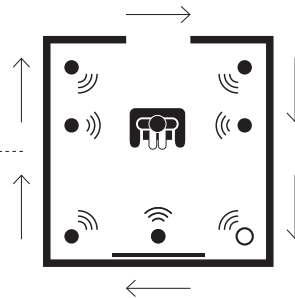
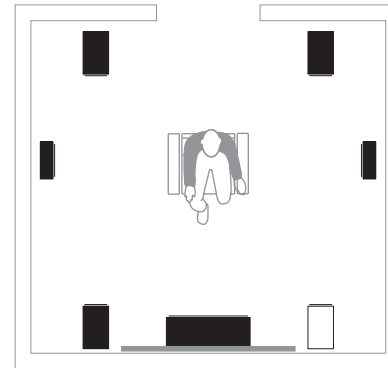

F Press the LINK & CONNECT button on the SOUND HUB.



NOTE:

System with SOUND HUB including HDMI module.



IN ADMIRATION OF MUSIC

3. Installation and Setup

3.4 Connecting an External Power Amplifier

Your SOUND HUB provides a stereo pair of preamplifier output RCA Phono sockets intended for the connection of a separate audio power amplifier. The preamplifier outputs mirror the SOUND HUB stereo left and right wireless speaker channels.

NOTE:

If the system combines wireless centre and surround speakers with wired front speakers, the wired outputs will be delayed slightly to time-align them with the wireless speakers. This will maintain accurate timing throughout the system.

NOTE:

The SOUND HUB's wireless left and right front speaker channels will be muted if the wired preamplifier outputs are connected. Likewise, a wirelessly connected subwoofer will be muted if the wired subwoofer output is connected.

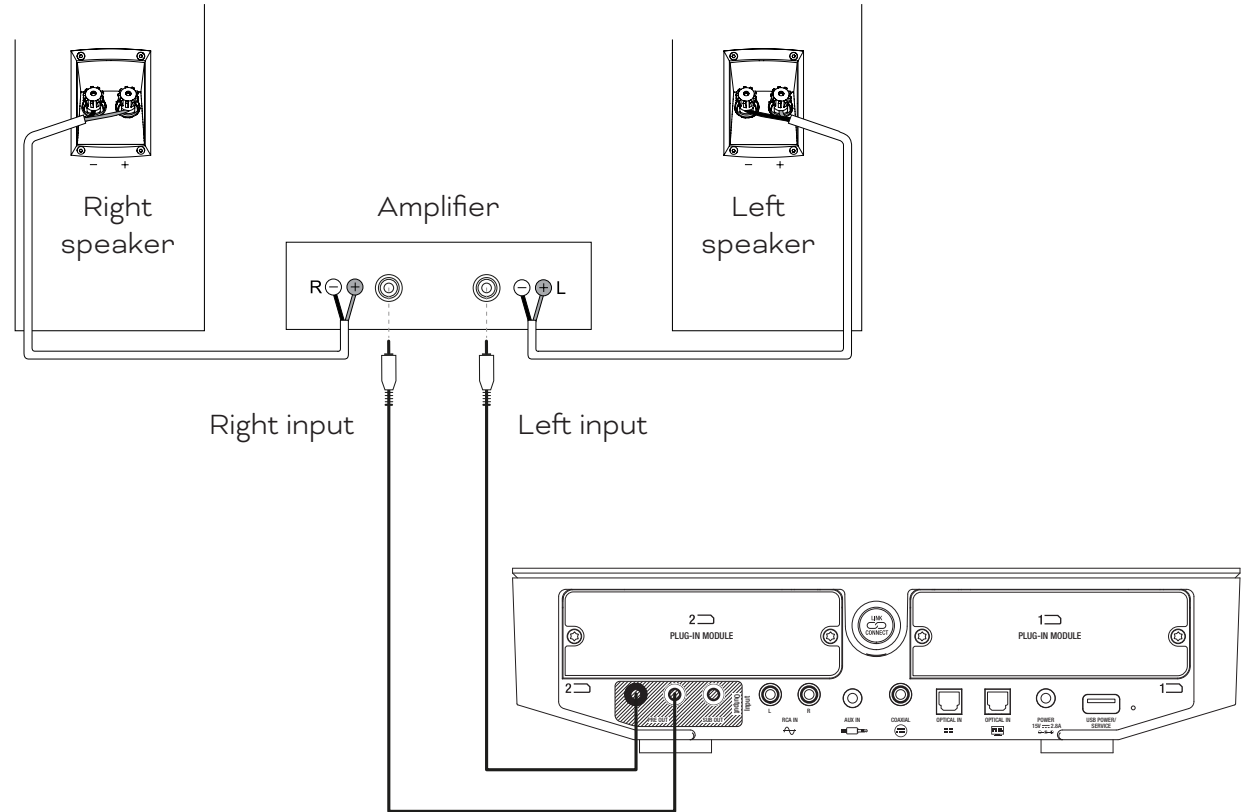

4. Connecting Audio Sources

With speakers connected to your SOUND HUB, you can connect wired and wireless audio sources.

4.1 Bluetooth Audio

If you wish to stream audio to your SOUND HUB and speakers from a Bluetooth device such as a mobile phone, tablet or laptop, the device and the SOUND HUB must be paired.

- To initiate Bluetooth pairing, the SOUND HUB Bluetooth input must first be selected using the Source Select button on the SOUND HUB front panel or remote control. The SOUND HUB display Bluetooth indicator will flash slowly.
- Now go to the mobile device you wish to connect, open its Bluetooth settings menu and look for “DALI SOUND HUB” in the list of available devices. Select “DALI SOUND HUB” to complete pairing. The SOUND HUB Bluetooth indicator will stop flashing.

NOTE:

The SOUND HUB Bluetooth input supports SBC, AAC, AptX and AptX HD formats.

NOTE:

Bluetooth pairing is only possible when the SOUND HUB Bluetooth input is selected. Further devices can be paired while an existing Bluetooth connection is active, however the Bluetooth indicator will not flash in this instance.

NOTE:

Your SOUND HUB can be paired with up to eight Bluetooth devices and connected to two devices simultaneously, although only one device at a time can play audio. When the pairing limit is reached, any newly paired device will delete the oldest paired device.

4. Connecting Audio Sources

4.1 Bluetooth Audio

After pairing a device with the SOUND HUB, you can subsequently connect it via Bluetooth independently of source selection. You can also wake the SOUND HUB from standby with Bluetooth if no other Bluetooth device is connected. You can disconnect currently connected Bluetooth device(s) from your SOUND HUB or change its Bluetooth name.

- To disconnect the currently connected Bluetooth device(s), press and hold the SOUND HUB front panel Mute (🔇) button. When the display shows “b_”, release the button. The pairings are not deleted, so the devices may still be reconnected later to the SOUND HUB as described above.
- The default SOUND HUB Bluetooth name is “DALI SOUND HUB”. Alternative names from “DALI SOUND HUB 1” to “DALI SOUND HUB 9” can be selected.
- To change the default name press and hold the SOUND HUB front panel Mute (🔇) button. When the display shows “b_”, turn the Volume Control until the desired name option is displayed, then release the Mute button. The new DALI SOUND HUB name will now be displayed when Bluetooth devices are paired or connected.

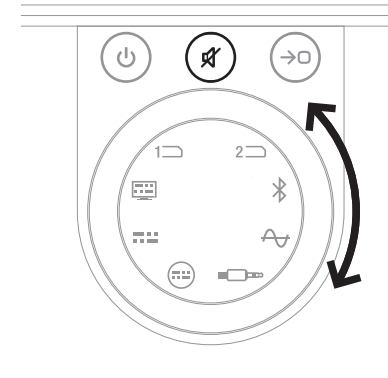

4. Connecting Audio Sources

4.2 Wired Audio

You can connect any wired audio sources you wish to use with your SOUND HUB to its rear panel connection sockets. These audio sources might include a CD player, a phono preamp equipped turntable, or a TV. [Diagram D 1 / page 5](#) illustrates the SOUND HUB connection sockets.

NOTE:

The USB socket found on the SOUND HUB rear panel cannot be used for connection of an audio source. However, it includes a power output and can be used to charge or power a range of USB devices. If your SOUND HUB is equipped with a DALI NPM module, you can connect USB audio sources to the USB socket found on this module.

We suggest that the SOUND HUB connection sockets are used for the following audio source types:

- **OPTICAL IN:** CD player or other audio source device equipped with an optical digital output.
- **OPTICAL IN (TV):** TV equipped with an optical digital output. If the TV is equipped with an HDMI (ARC) connection and your SOUND HUB is fitted with the DALI HDMI module, always use this in preference to the optical connection.
- **COAXIAL IN:** CD player or other audio source device equipped with a coaxial digital output.
- **RCA IN L(left) & R(right):** CD player, phono preamplifier or other audio source device equipped with a line level analogue output.
- **AUX IN (mini-jack):** Portable music player or other audio source device equipped with a line level or headphone level analogue audio output.

If your SOUND HUB is fitted with an HDMI module, this module provides an input for HDMI ARC or eARC equipped TVs. The HDMI module also supports Dolby Digital and DTS decoding for broadcast to multi-channel speaker systems comprising up to 7.1 channels. Decoding is optional, as eARC TVs are able to transmit un-encoded audio to the SOUND HUB. Installation and use of the HDMI module is described and illustrated in [Section 8 / page 46](#).



4. Connecting Audio Sources

4.3 Connecting Network Audio Streams

If your SOUND HUB is fitted with an NPM module it will be able to connect to a home WiFi or Ethernet network and play audio from a wide range of music streaming services, network music libraries and internet radio stations. Use of the NPM module is described in [Section 7 / page 38](#).

5. Using Your SOUND HUB

With your SOUND HUB installation complete and speakers connected, you can begin to enjoy some music.

SOUND HUB control functions can be accessed from either the SOUND HUB front panel or remote control. The front panel buttons and display are illustrated in [Diagram D 2 / page 6](#). The remote control buttons are illustrated in [Diagram D 3 / page 7](#).

5.1 Standby

Your SOUND HUB has a low energy consumption Standby Mode that can be engaged or disengaged by pressing either the front panel or remote control Standby (⏻) button. Your SOUND HUB will also automatically switch to Standby Mode after twenty minutes of inactivity. You can disengage Standby Mode by pressing either the front panel or remote control Standby (⏻) button. If Auto Signal Sensing is engaged, Standby Mode will disengage automatically when a signal is present on any input.

Standby button

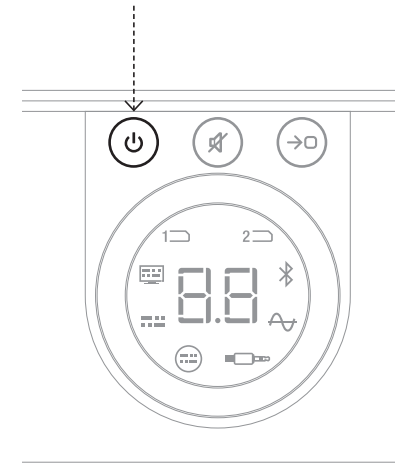

5. Using Your SOUND HUB

5.2 Volume

To control the overall volume, either turn the SOUND HUB front panel volume control or press the remote control volume up (▲) and volume down (▼) buttons.

NOTE:

DALI CALLISTO C wireless speaker models also offer top panel touchpad volume control.

NOTE:

If a Bluetooth or network audio source (with an NPM module installed) is playing, you may also be able to control SOUND HUB volume from a source device or app.

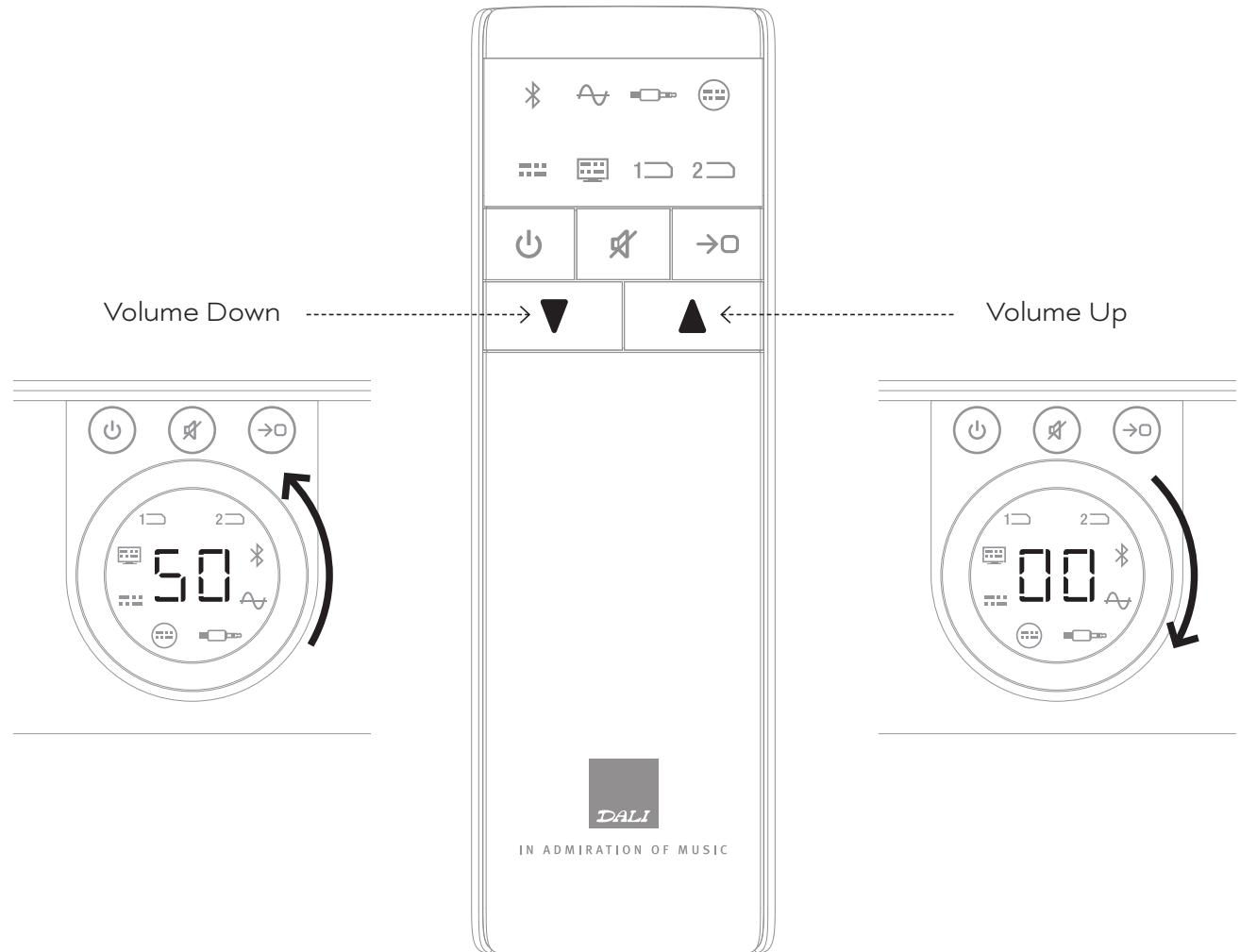

5. Using Your SOUND HUB

5.3 Mute

To silence your SOUND HUB, press either the front panel or remote control mute (🔇) button. To restore the audio, press either mute button again.

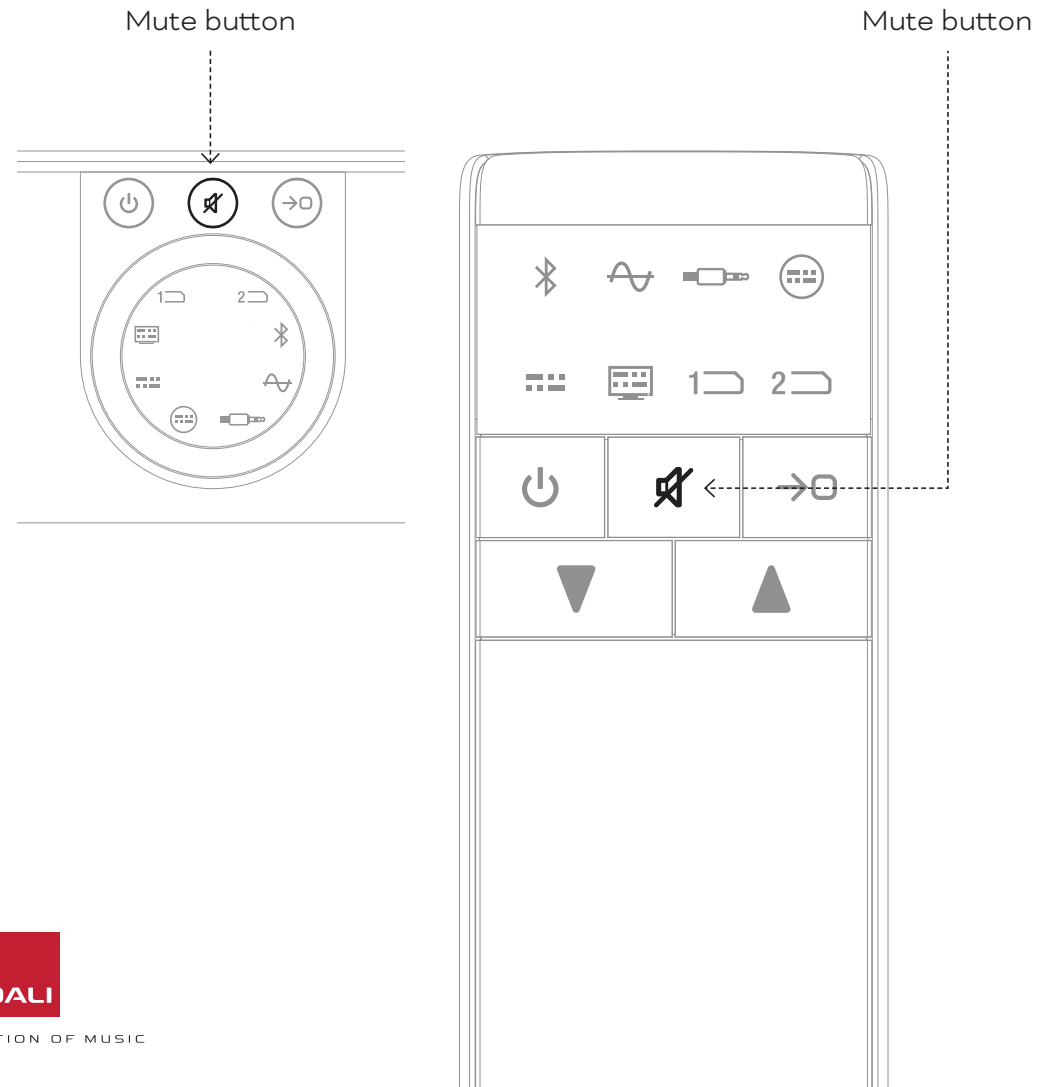

5. Using Your SOUND HUB

5.4 Source Selection

To select a SOUND HUB audio source, press either the SOUND HUB front panel or remote control source selection (→◻) button. NPM or HDMI sources can only be selected if the necessary modules are installed in the SOUND HUB. The currently selected source is indicated by the illuminated icon in the SOUND HUB display.

If your SOUND HUB has NPM or HDMI modules installed, depending on which installation slot they occupy, their selection will be indicated by the “Slot 1” (1◻) or “Slot 2” (2◻) icon illuminating in the SOUND HUB display.

NOTE:

Depending on whether SOUND HUB Auto Signal Sensing is engaged, sources may select automatically when they become active. Auto Signal Sensing is described in [Section 5.5 / page 25](#).

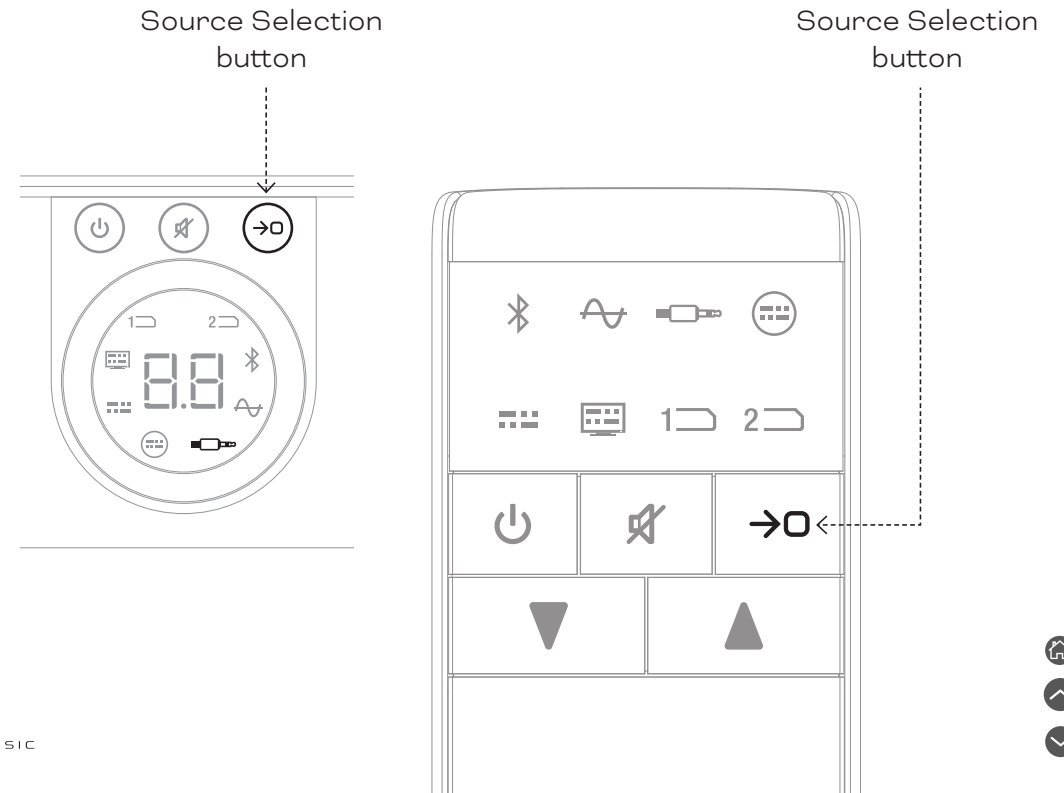

5. Using Your SOUND HUB

5.5 Auto Signal Sensing

Any SOUND HUB input except AUX IN will select automatically when a signal is present, unless an alternative input is already playing. Auto sensing will also disengage Standby Mode.

NOTE:

RCA IN, COAXIAL IN and OPTICAL IN are all automatically selected when a live audio signal is detected. OPTICAL IN (TV) will be automatically selected when the source TV is simply switched on – an audio signal is not necessary. The Bluetooth and NPM inputs will automatically be selected when the source Play button is pressed. The HDMI input will automatically be selected when a connected TV is switched on.

NOTE:

To avoid unexpected and unwanted input selection, it is good practice to switch off or stop playback on unselected inputs.

Auto Signal Sensing can be disengaged if desired, leaving only manual source selection available.

- With your SOUND HUB switched on, press and hold the front panel Source Selection button and turn the Volume Control until the desired Auto Signal Sensing option is displayed: “AU” indicates Auto Signal Sensing On, and “__” indicates Auto Signal Sensing Off. Now release the Source Selection button.

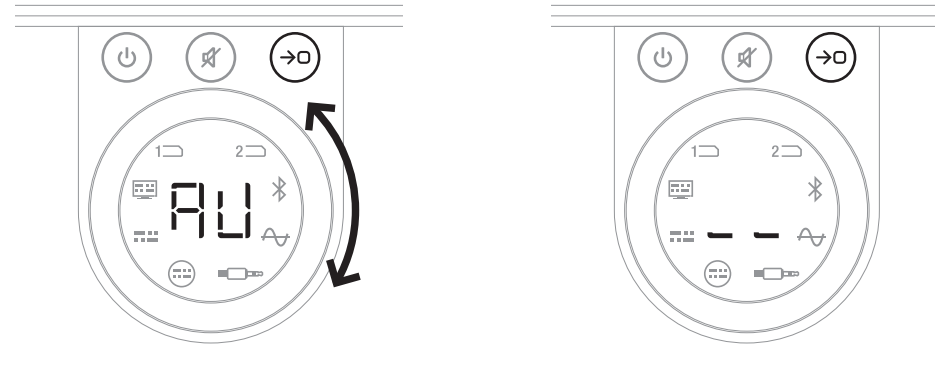

5. Using Your SOUND HUB

5.6 Display and Indicator Illumination

The brightness of your SOUND HUB front panel display and the volume level display on connected CALLISTO C or RUBICON C speakers can be adjusted. With your SOUND HUB switched on, press and hold the front panel Standby button and turn the Volume Control until the desired brightness option is displayed, then release the Standby button.

NOTE:

At the lowest brightness setting, volume level illumination on connected speakers is only visible when volume adjustments are made.

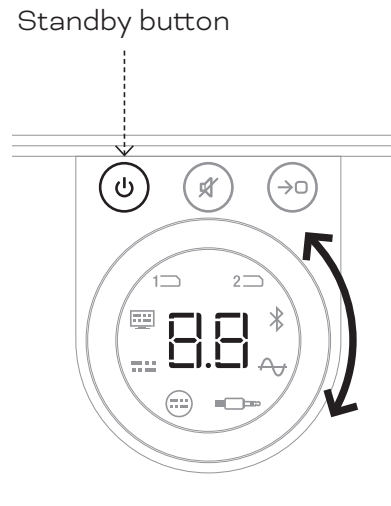

5. Using Your SOUND HUB

5.7 Speaker Balance Adjustment

Speaker Balance Adjustment is only available for wirelessly connected speakers.

You can adjust the relative volume level of each wireless speaker or subwoofer connected to your SOUND HUB. Adjusting the relative volume can be useful:

- to adjust the balance between a stereo pair of speakers and a subwoofer.
- to balance the volume of multiple stereo pairs of speakers.
- to optimise the volume of the speakers in a multi-channel system.

The aim of Speaker Balance Adjustment is to have all the speakers playing at approximately the same volume at the listening position. Up to $\pm 9\text{dB}$ of adjustment for each channel is available. The Speaker Balance Adjustment routine is described in the following paragraphs.

Before you start, ensure that all speakers and any subwoofer are switched on and wirelessly connected to the SOUND HUB.

- With your SOUND HUB switched on, simultaneously press and hold the front panel Mute and Source Select buttons **A**.
- When you hear a noise signal from the first speaker, release the Mute and Source Select buttons. The speaker under adjustment will be indicated on the SOUND HUB top panel display and the noise signal will continue to enable you to judge the volume. Wireless speakers fitted with a volume display will also illuminate to indicate the one being adjusted.
- The SOUND HUB volume control **B** or the remote control volume up and down buttons **C** can now be used to adjust the relative volume of the selected speaker. The SOUND HUB volume display will show the adjustment.

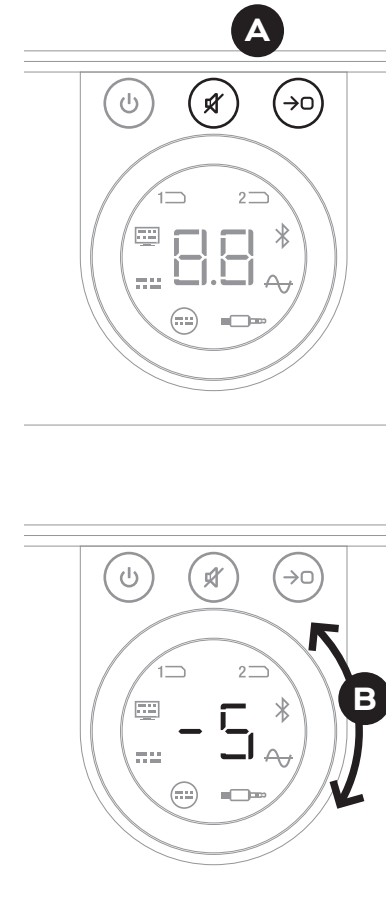

NOTE:

Speaker Balance adjustment is particularly relevant if an HDMI module is installed in your SOUND HUB and you play multi-channel audio material.

5. Using Your SOUND HUB

5.7 Speaker Balance Adjustment

- Press the front panel Source Select button **C** to move to the next speaker, or press the Mute button **D** to return to the previous speaker, and adjust the balance. If no adjustment is required for a speaker, press the Source Select button again to move on to the next one.
- When all the required speaker or subwoofer adjustments are made, press and hold the Source Select button **E** to save and exit from Speaker Balance Adjustment. If you wish to exit Speaker Balance Adjustment without saving any changes, press and hold the front panel Standby button.

Once initial volume balance has been achieved you may find it beneficial to revisit the adjustment routine as you become more familiar with the performance of your system. This is especially likely with the multi-channel systems made possible by the SOUND HUB HDMI module.

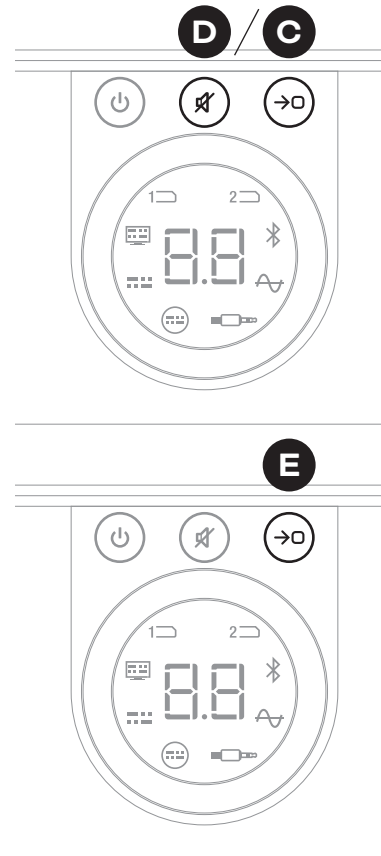

IN ADMIRATION OF MUSIC

NOTE:

The default order of Speaker Balance Adjustment is: Centre, Front Right, Side Right, Rear Right, Rear Left, Side Left, Front Left, Subwoofer. Uninstalled speaker positions will be omitted. If multiple speakers are installed at a single channel position, they will be available for adjustment independently in the order which they were originally connected.

NOTE:

Your SOUND HUB will automatically return to normal operation without saving speaker balance adjustments if no action is taken for two minutes.

5. Using Your SOUND HUB

5.8 Speaker Distance Adjustment

Speaker Distance Adjustment is only available for wirelessly connected speakers.

Depending on the relative distance of each speaker or subwoofer from the listening position it can be beneficial to introduce relative time delays to some channels to ensure that audio arrives at the listening position in exact synchronicity. This is especially significant in multi-channel systems. The SOUND HUB will automatically calculate any appropriate relative time delays using the measured distance from the listening position to the speakers. This is described in the following section.

Before you start, measure and record the distance in metres, to an accuracy of $\pm 0.05\text{m}$ (5cm), from each speaker to the listening position. Ensure that all speakers and any subwoofer are switched on and connected wirelessly to the SOUND HUB.

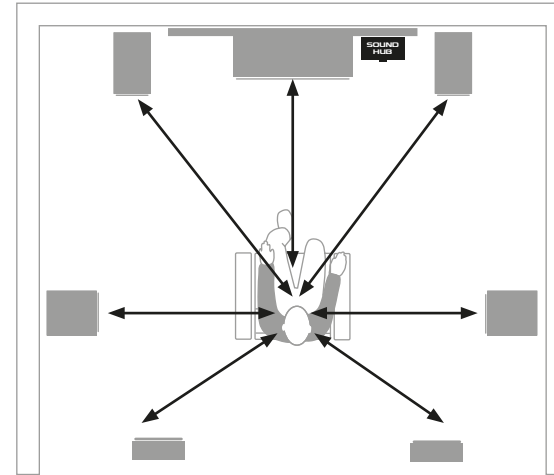

NOTE:

Speaker Distance adjustment is particularly relevant if an HDMI module is installed in your SOUND HUB and you play multi-channel audio material.

5. Using Your SOUND HUB

5.8 Speaker Distance Adjustment

- With your SOUND HUB switched on, simultaneously press and hold the front panel Standby and Source Select buttons **A**. When you hear an audio prompt from the first speaker, release the Standby and Source Select buttons. Wireless speakers fitted with a volume display will also illuminate to indicate the one being adjusted.
- Turn the SOUND HUB volume control **B** or use the remote control volume up and down buttons **C** to adjust the distance of the selected speaker. The SOUND HUB distance display will show the adjustment from 1.0 to 7.0 metres.

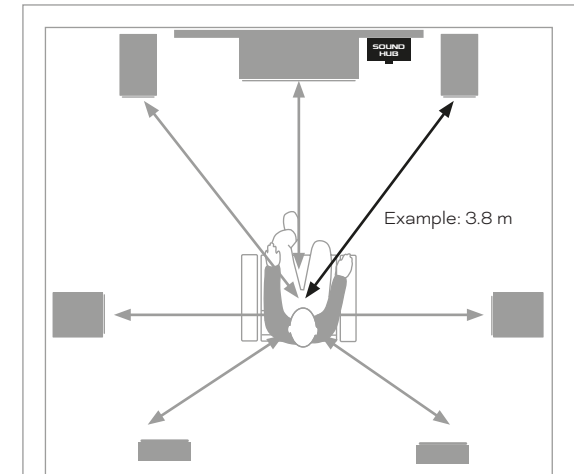
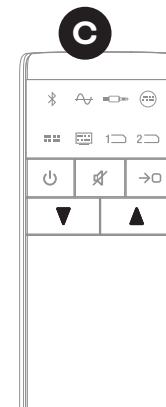
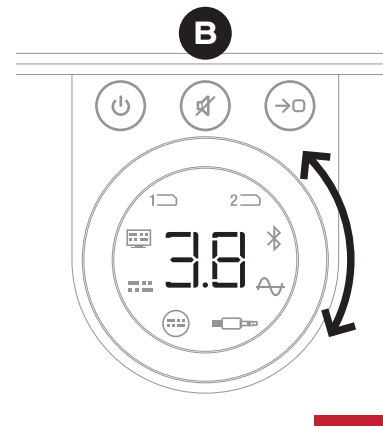
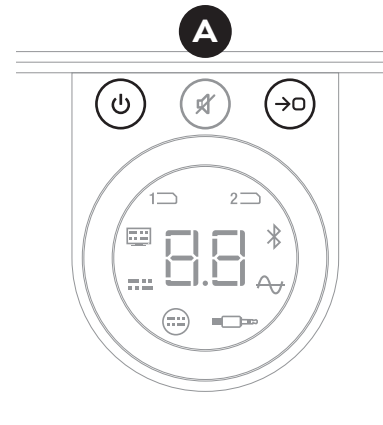

5. Using Your SOUND HUB

5.8 Speaker Distance Adjustment

NOTE:

The default order of Speaker Distance Adjustment is: Centre, Front Right, Side Right, Rear Right, Rear Left, Side Left, Front Left, Subwoofer. Uninstalled speaker positions will be omitted. If multiple speakers are installed at a single channel position, they will be available for adjustment independently in the order which they were originally connected.

- Press the front panel Source Select button **C** to move to the next speaker, or press the Mute button **D** to return to the previous speaker, and adjust the distance.
- When all the required speaker or subwoofer distance adjustments are made, press and hold the Source Select button **E** to save and exit from Speaker Distance Adjustment. If you wish to exit Speaker Distance Adjustment without saving any changes, press and hold the front panel Standby button.

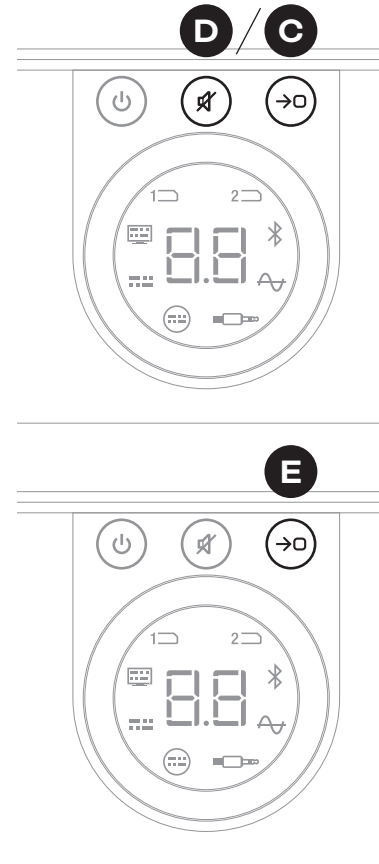

NOTE:

Your SOUND HUB will automatically return to normal operation without saving speaker distance adjustments if no action is taken for two minutes.

6. Trouble-Shooting and Maintaining Your SOUND HUB

Your SOUND HUB should not require any maintenance beyond the kind of care that you would give other high value items in your home, however you may find the information in the following paragraphs occasionally useful.

6.1 Cleaning

Use a soft dry cloth to dust the SOUND HUB case. We do not recommend the use of any cleaning fluids or sprays, but if you wish to use furniture polish, apply it to a cloth rather than directly to the case.

6. Trouble-Shooting and Maintaining Your SOUND HUB

6.2 Wireless Connection Channel Options

Your SOUND HUB will by default automatically select the least congested radio frequency channel for wireless speaker connections. However, in homes and environments busy with technology it is sometimes possible for a SOUND HUB temporarily to lose the connection with the speakers when the wireless channel in use becomes congested. You may notice your music repeatedly drops out for a moment as the wireless connection automatically switches to an alternative channel.

The first potential solution to this problem is to ensure that any unused wireless equipment nearby is switched off. Even when in standby or sleep mode, some wireless equipment will still broadcast a signal and consume bandwidth, so if it is unused, it is best fully switched off.

If however you still experience occasional drop-outs, you can reconfigure your SOUND HUB to remain connected via a fixed wireless channel rather than switching channels automatically. This may prompt other wireless equipment in your home to automatically switch to alternative channels and release more bandwidth for your wireless DALI system.

To configure your SOUND HUB to use a fixed wireless broadcast channel follow the six steps below:

- Switch on the SOUND HUB **A**.
- Press and hold the rear panel LINK & CONNECT button **B** for 10 seconds to engage wireless channel configuration mode, then release the LINK & CONNECT button.

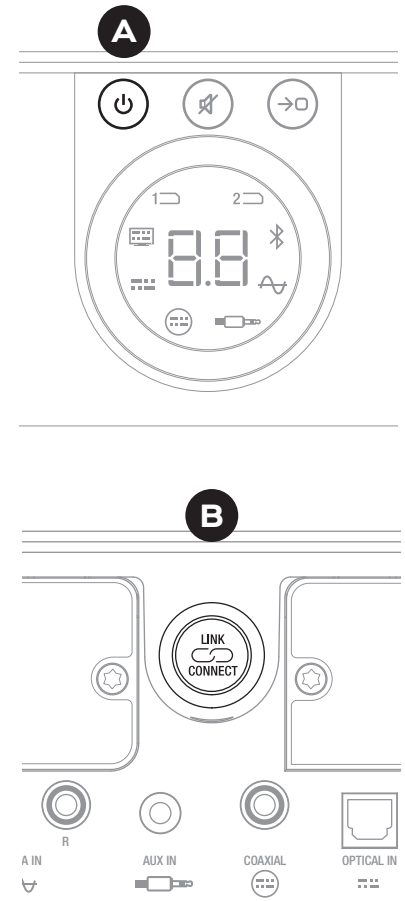

6. Trouble-Shooting and Maintaining Your SOUND HUB

6.2 Wireless Connection Channel Options

- Turn the SOUND HUB volume control **C** to select from the A (Automatic), 1, 2 and 3 channel options shown on the display.
- After making the new selection, the currently used channel will be shown in the display as “c.1”, “c.2”, “c.3” **D** if it was manually selected. If “A” (Automatic) was selected, the channel is shown as “c1”, “c2”, “c3” **E** (without the dot), indicating that the channel is automatically selected.
- Press the LINK & CONNECT button **F** to return the SOUND HUB to normal operation.
- You should operate your SOUND HUB with a newly selected fixed wireless channel for some time to see if performance improves before trying another wireless channel option.

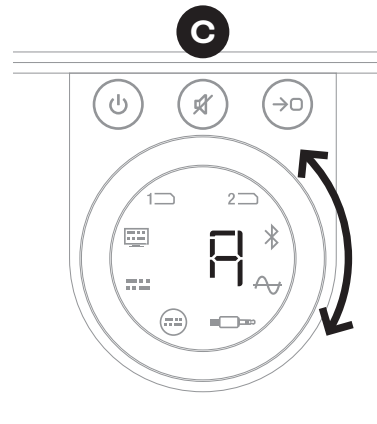

Manually selected channel

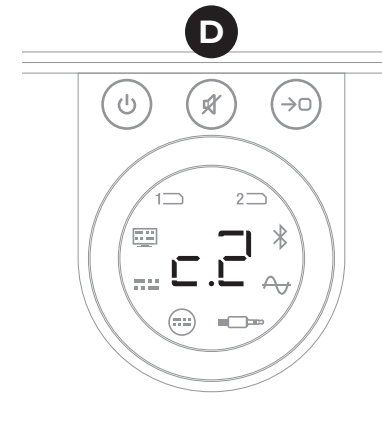

Automatically selected channel

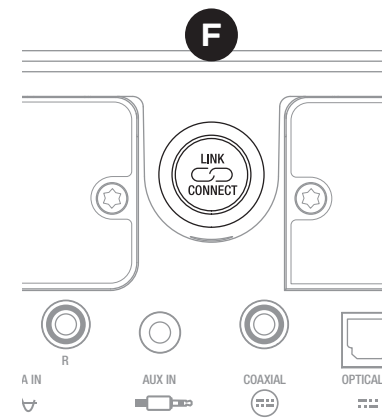
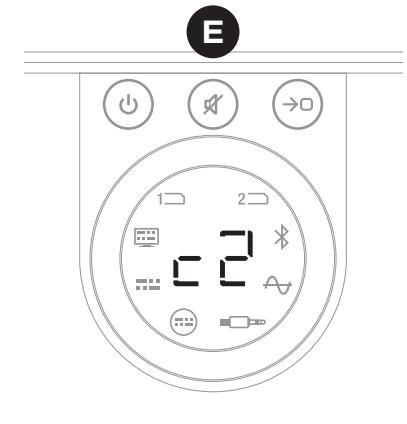

6. Trouble-Shooting and Maintaining Your SOUND HUB

6.3 Reset to Defaults

If at any time you need to connect your SOUND HUB to different speakers or to erase its Bluetooth pairing memory, it will require resetting to its defaults. To reset your SOUND HUB follow the steps alongside.

- Switch off the SOUND HUB **A**.
- Switch on the SOUND HUB by pressing the Standby button while simultaneously pressing and holding the Mute and Source Select buttons **B**.
- When the SOUND HUB front panel display shows “==” **C** release the buttons.
- Your SOUND HUB will now be reset.
- Switch off the SOUND HUB and then back on.

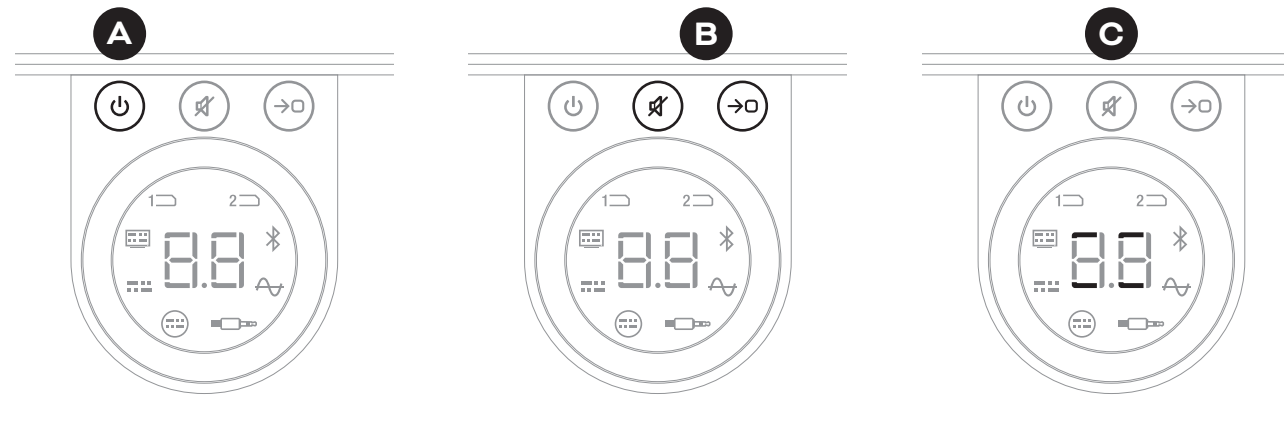

IN ADMIRATION OF MUSIC

6. Trouble-Shooting and Maintaining Your SOUND HUB

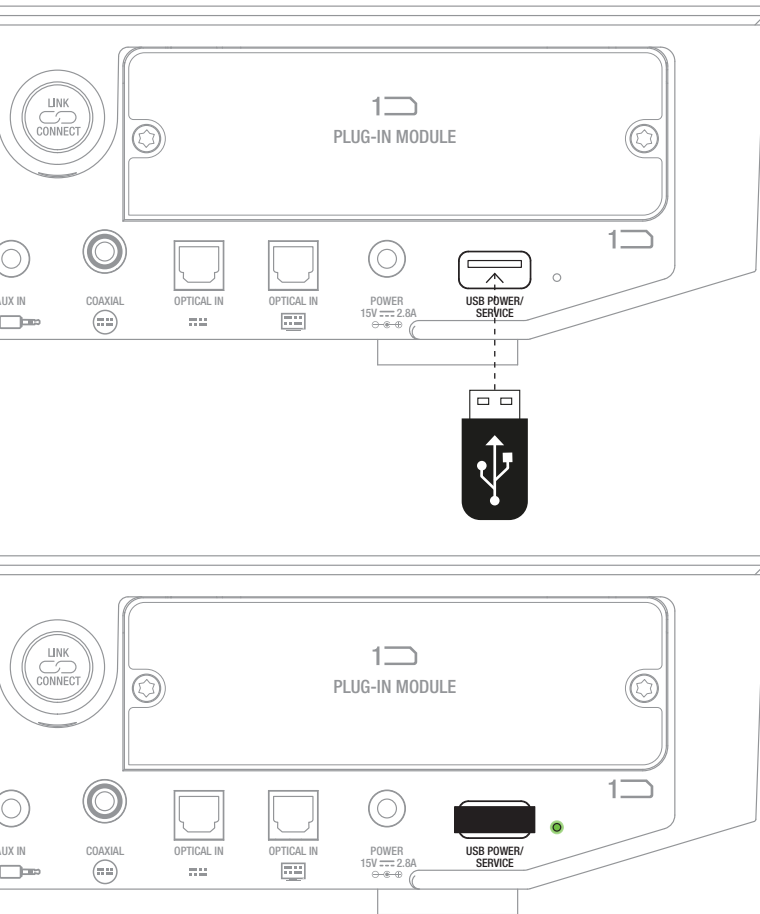

6.4 Firmware Update

DALI may occasionally release updated firmware for your SOUND HUB. Updated firmware may improve performance and reliability or introduce new features. Firmware updates will be made available for download from the DALI website. To install a firmware update follow the steps below.

- Download the firmware file from the DALI website (see link below).
- Transfer the firmware file to an empty USB memory stick using the dedicated DALI tool available for Windows and macOS.
- Disconnect the SOUND HUB from its power supply.
- Insert the USB memory stick into the “USB Power/Service” socket on the SOUND HUB rear panel.
- Reconnect the SOUND HUB power supply and wait for the small indicator next to the USB Power/Service socket to blink green.
- Remove the USB memory stick from the SOUND HUB.
- The SOUND HUB firmware will now be updated.



www.dali-speakers.com/firmware

6. Trouble-Shooting and Maintaining Your SOUND HUB

6.5 Disposal

If you want to dispose of this product, do not mix it with general household waste. There is a separate collection system for used electronic products in accordance with legislation that requires proper treatment, recovery and recycling. Private households in the EU member states, Switzerland, Liechtenstein and Norway may return their used electronic products free of charge to designated collection facilities or to a retailer (if you purchase a similar new one). If you reside in countries not mentioned above, please contact your local authorities for the correct method of disposal. By following this process, you will ensure that your disposed product undergoes the necessary treatment, recovery and recycling and thus prevent potential negative effects on the environment and human health.

7. Installing and Using the SOUND HUB NPM BluOS Module

SOUND HUB NPM BluOS Module



BluOS®



IN ADMIRATION OF MUSIC



7. Installing and Using the SOUND HUB NPM BluOS Module

The NPM modules employ the BluOS streaming platform to enable the SOUND HUB to connect to a home WiFi or Ethernet network and play audio from a wide range of music streaming services, network music libraries, internet radio stations and USB storage. The NPM-2i module differs from the NPM-1 module by incorporating Apple Airplay 2 streaming technology.

7.1 Installation

The NPM module pack includes the following items:

- NPM module
- USB WiFi Dongle
- USB extension cable

To install an NPM module in your SOUND HUB follow the steps on the following page.

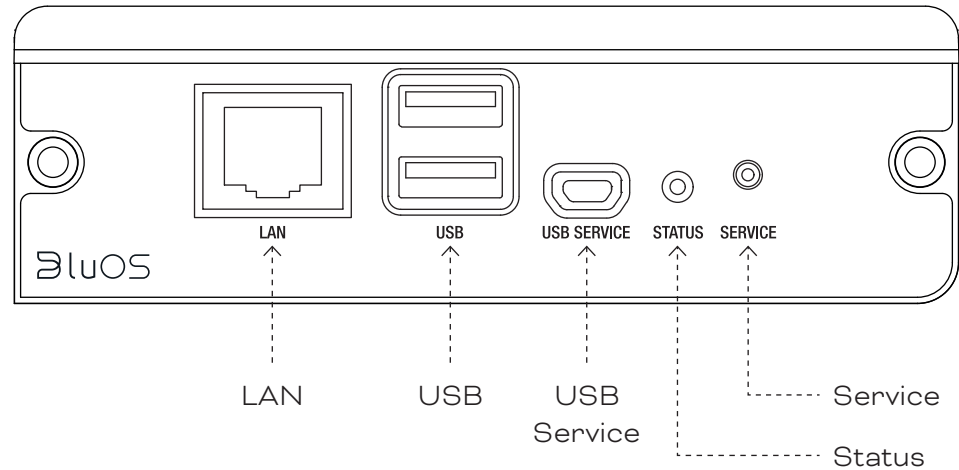

NOTE:

If an NPM module is to be removed, the SOUND HUB power supply must first be disconnected.

7. Installing and Using the SOUND HUB NPM BluOS Module

7.1 Installation

- Disconnect the SOUND HUB from its power supply. **A**
- Use a Torx 10 screwdriver to remove the two screws and the cover from an unused SOUND HUB rear panel module slot. **B**
- Slide the NPM module (with its handle uppermost) into a free module slot until it is aligned with the rear panel of the SOUND HUB. **C**
- Secure the NPM module by reinserting the two screws in the appropriate holes. Be careful not to over-tighten the screws. **D**
- Reconnect the SOUND HUB to its power supply, but do not yet switch on the SOUND HUB. **E**

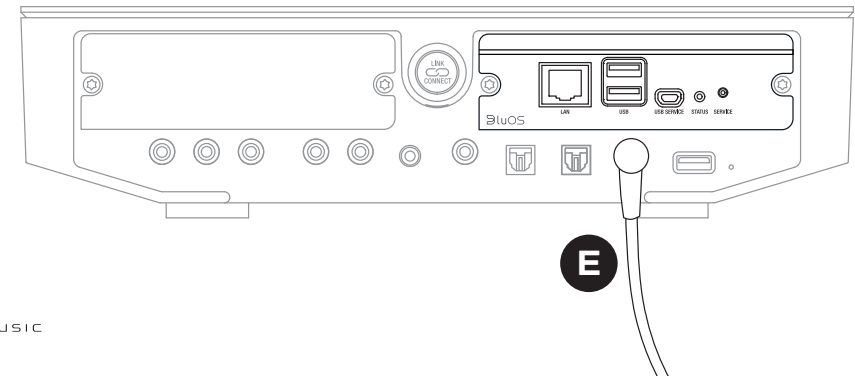
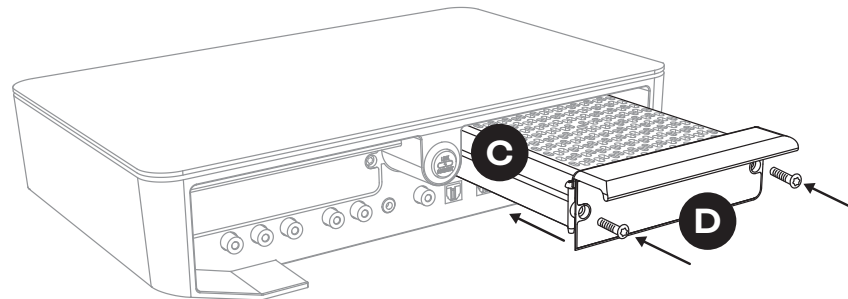
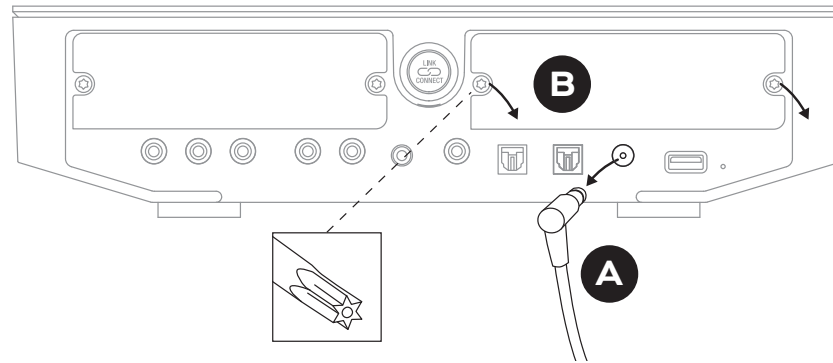

7. Installing and Using the SOUND HUB NPM BluOS Module

7.2 Network Connection

NPM modules require a connection to your home network and the internet. The home network connection can be either wired via an Ethernet cable connected to your home router, or wireless via your home WiFi network.

- If your preference is to connect via your WiFi network, insert the supplied USB WiFi Dongle in one of the NPM rear panel USB sockets. **A**
- If your preference is for a wired network connection, use an Ethernet cable to connect the NPM rear panel network socket (labelled “LAN”) to a free network socket on your home router. **B**

D9: NPM-2i module rear panel

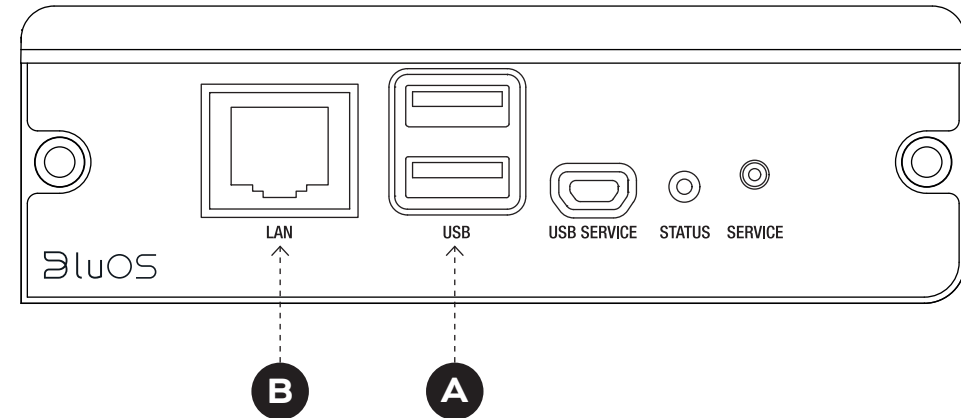

7. Installing and Using the SOUND HUB NPM BluOS Module

7.2 Network Connection

Configuration and access to the functions provided by the NPM module in your SOUND HUB requires the download and use of the BluOS Controller app on a mobile or tablet device or a computer. Versions of the app are available for iOS, Android and Kindle Fire handheld devices, and macOS and Windows computers. Only the iOS, Android and Kindle Fire versions of the app provide network configuration facilities. You can find more information at:

www.bluesound.com/downloads

- Once you have downloaded the BluOS Controller app, installed the NPM module in your SOUND HUB, and either inserted its WiFi Dongle or made a wired connection to your home network, switch on your SOUND HUB and launch the BluOS Controller app.

If your NPM module uses a wired connection to your home network it will be available for use immediately when you launch the BluOS Controller app. If you wish to connect via your WiFi network however there are a few configuration steps required using the iOS, Android or Kindle Fire version of the BluOS Controller app.

NOTE:

You may need to know your WiFi network name and password to complete the configuration process.

NOTE:









Depending on your use of the iOS, Android or Kindle Fire version of the BluOS Controller app the details of the network configuration steps will vary.

- With the BluOS Controller app launched and the SOUND HUB switched on follow the app procedure to install a new BluOS device.
- In the BluOS Controller app, select the “Add A Player” option and follow the prompts to connect your NPM-2i equipped SOUND HUB to your WiFi network.

7. Installing and Using the SOUND HUB NPM BluOS Module

7.2 Network Connection

During and after the network connection process, the “Status” LED located on the NPM rear panel will illuminate to indicate different setup states. These are described in the following table:

	LED Blink Code	Description
	Steady Blue	Connected to WiFi and ready for use
	Flashing Red/Green	Re-starting
	Solid Green	WiFi network connection mode
	Flashing Green	Connecting to WiFi network
	Steady White	Indexing available network music files
	Pulsing White	Firmware update available
	Alternate flashing Red/Green	Firmware update in progress
	Flashing Red	Reset to Defaults underway
	Continuous Red	Error (restart the SOUND HUB)

T2: LED Blink Codes



7. Installing and Using the SOUND HUB NPM BluOS Module

7.3 Using Your NPM equipped SOUND HUB

With your NPM equipped SOUND HUB connected to your home network and the Internet you will be able to use the BluOS Controller app to select and stream music from a wide variety of music streaming services and internet radio stations. You will also be able to use technologies such as Apple Airplay 2 (NPM-2i only), Spotify Connect and Tidal Connect to play streams directly from streaming service apps or to access and play locally stored audio files.

You will also be able to stream audio files from home network music storage and from USB storage connected to one of the NPM module rear panel USB sockets.

NOTE:

NPM modules are able to play a wide range of audio file formats. These include: MP3, AAC, WMA, WMA-L, OGG, FLAC, ALAC, WAV, AIFF and MQA.

For more information about the BluOS ecosystem and features please visit: www.bluos.net

- On launching a network audio stream via the BluOS Controller app or a stand-alone audio streaming app, the SOUND HUB will automatically switch to the NPM module input and play the stream.
- Depending on which SOUND HUB slot the NPM module is installed in, a “Slot 1” (icon) or “Slot 2” (icon) will illuminate on the SOUND HUB display to indicate that the NPM module is the selected source.
- If an alternative SOUND HUB input is selected while a NPM stream is playing, depending on the source app or device, the network stream will either pause or stop. Restarting the stream will automatically switch back to the NPM input.
- The BluOS app provides options to select and play network streamed audio, internet radio stations or audio files stored locally on either network or USB hardware.
- The BluOS Controller App can also be used to switch between SOUND HUB inputs.
- Presets created in the BluOS app can be selected from the SOUND HUB front panel controls. With the SOUND HUB in Standby Mode, turning the volume wheel will display the preset numbers. When the required preset is displayed, switch on the SOUND HUB by pressing the Standby button.



7. Installing and Using the SOUND HUB NPM BluOS Module

7.4 NPM Reset to Defaults

If you wish to connect your NPM equipped SOUND HUB to an alternative WiFi network it will require resetting to its defaults. To reset your NPM follow the steps below.

- Switch the SOUND HUB to Standby but leave it connected to its power supply. **A**
- Press and hold the SOUND HUB Mute button **B** while looking at the NPM rear panel indicator. **C**
- After holding the Mute button for 20 to 30 seconds, the Status LED will begin flashing Red (**C** = 🔴). Release the Mute button **B**.
- After a short delay the indicator will begin flashing Green (**C** = 🟢) to indicate that the NPM reset is complete and it has restarted in network connection mode.

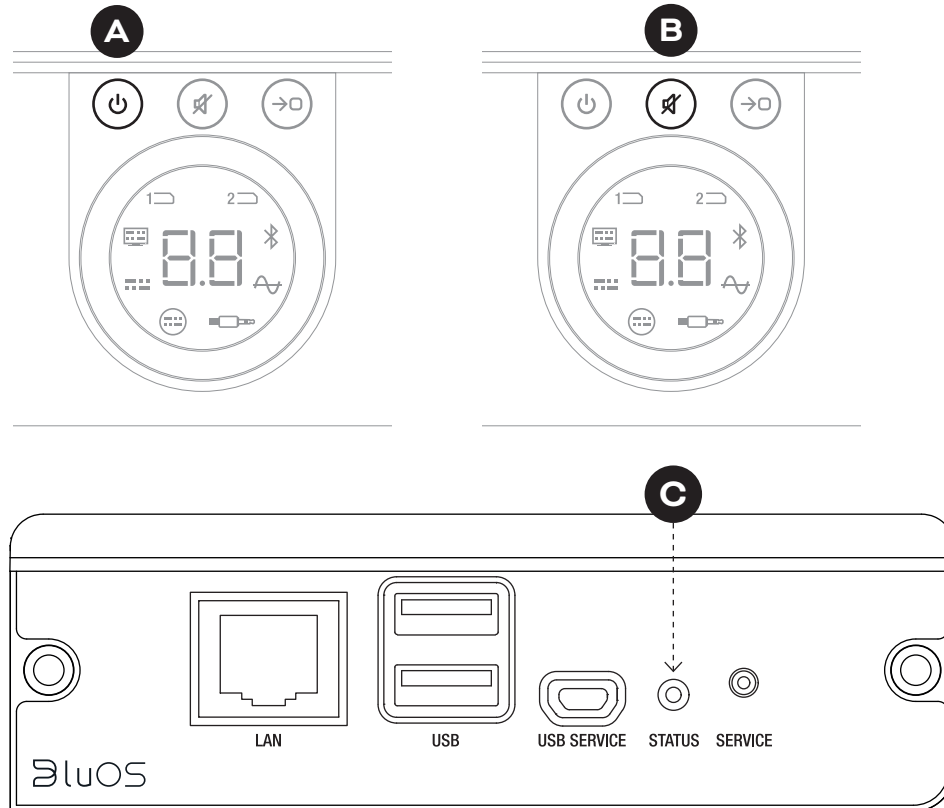

8. Installing and Using the SOUND HUB HDMI Module

SOUND HUB HDMI Module



IN ADMIRATION OF MUSIC



8. Installing and Using the SOUND HUB HDMI Module

The SOUND HUB HDMI module provides an input for HDMI ARC and eARC equipped TVs and incorporates Dolby Digital and DTS decoding to enable broadcast to multi-channel speaker systems.

HDMI ARC enables uncompressed stereo audio or compressed multi-channel audio, at up to 5.1 format, to be output from the TV to an external device. If however your TV is equipped with eARC (sometimes known as HDMI 2.X) it will be able to output uncompressed multi-channel audio, at up to 7.1 format. If your TV provides both ARC and eARC options, we recommend using the latter option.

D 10: HDMI module rear panel

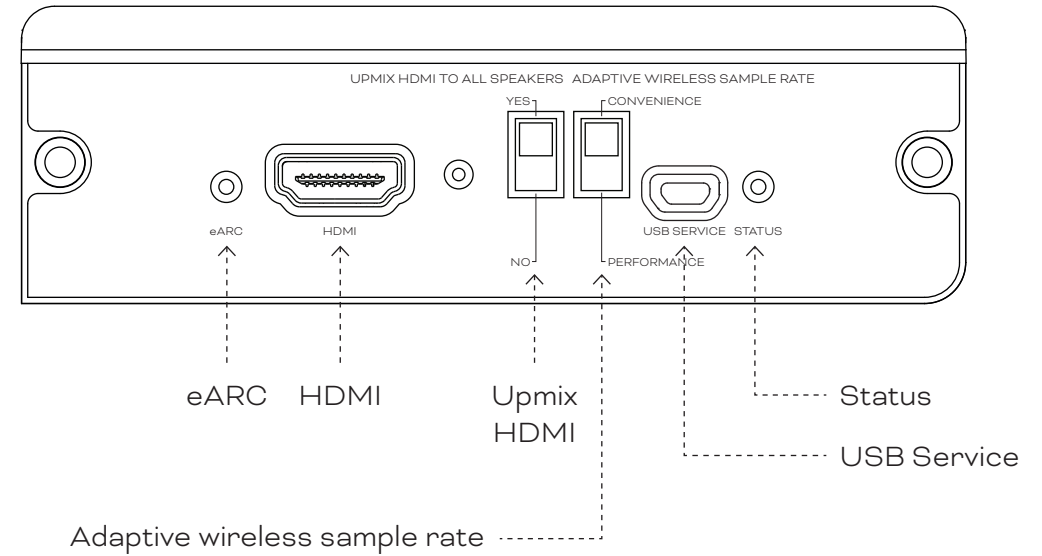

8. Installing and Using the SOUND HUB HDMI Module

8.1 Installation

To install the HDMI module in your SOUND HUB, follow the steps below.

- Disconnect the SOUND HUB from its power supply. **A**
- Use a Torx 10 screwdriver to remove the two screws and the cover from an unused SOUND HUB rear panel module slot. **B**
- Slide the HDMI module (with its handle uppermost) into a free module slot until it is aligned with the rear panel of the SOUND HUB. **C**
- Secure the HDMI module by reinserting the two screws in the appropriate holes. Be careful not to over-tighten the screws. **D**

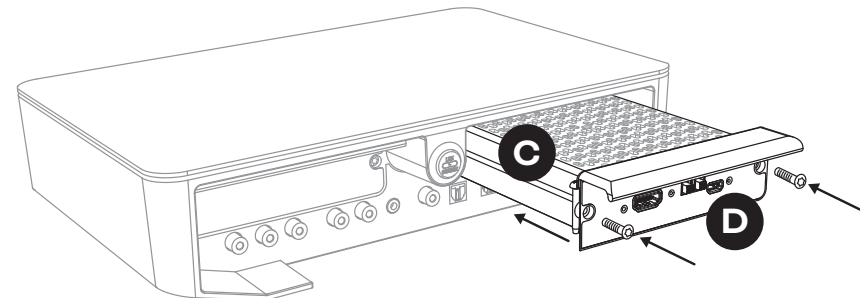
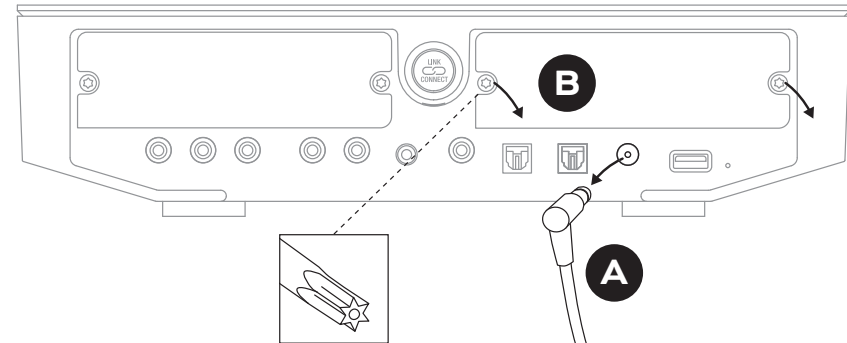

8. Installing and Using the SOUND HUB HDMI Module

8.1 Installation

- Use an HDMI cable to connect the SOUND HUB HDMI module input socket **E** to an appropriate TV HDMI connection socket. The TV HDMI connection socket must be labelled HDMI ARC or HDMI eARC. Refer to the TV user manual to help you identify the correct socket.
- Reconnect the SOUND HUB to its power supply **F** and switch it on.

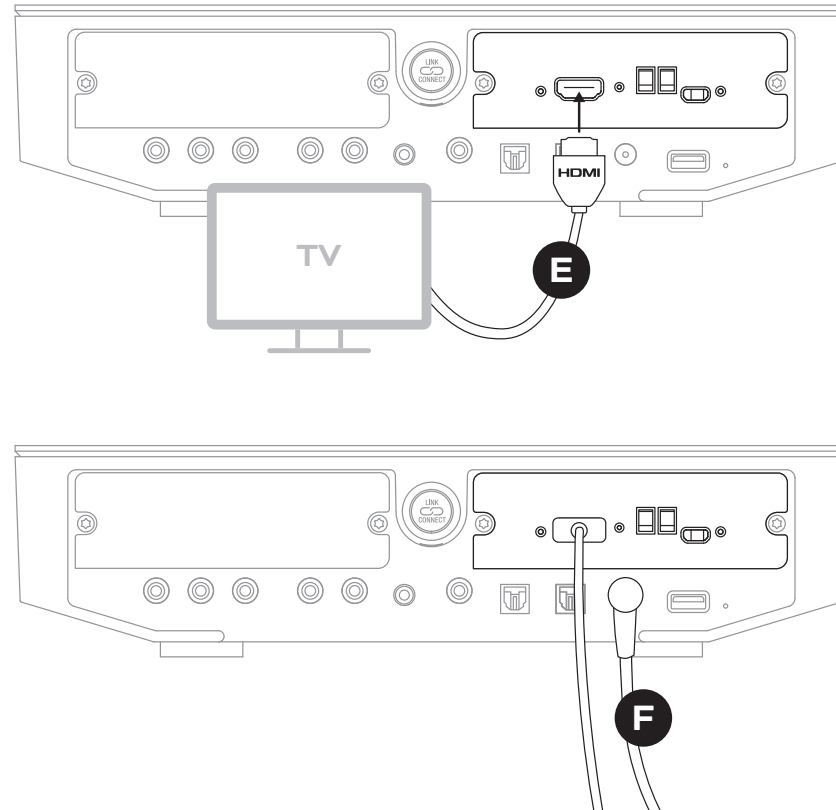

NOTE:

If an HDMI module is to be removed, the SOUND HUB power supply must first be disconnected. The SOUND HUB must then be reset to its defaults and re-set up before being used again.

NOTE:

The HDMI module rear panel Status indicator will illuminate green to confirm an HDMI eARC TV connection.

8. Installing and Using the SOUND HUB HDMI Module

8.2 Configuring Your HDMI Equipped SOUND HUB

D 11: HDMI module

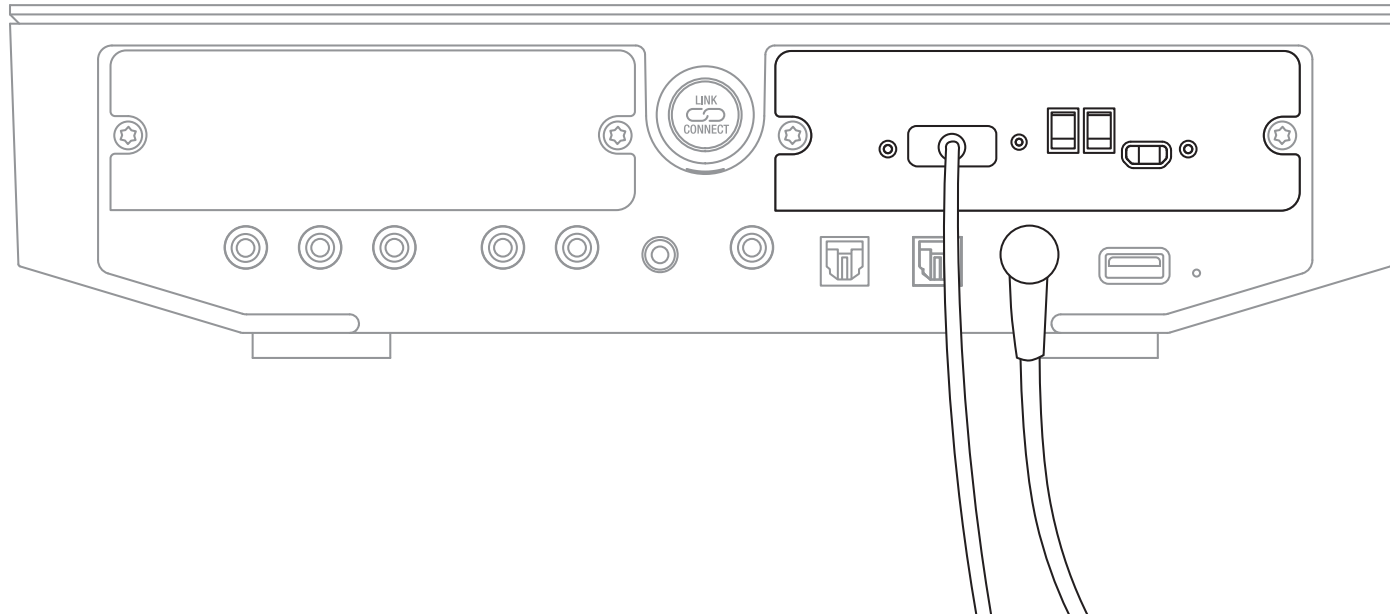

NOTE:

If you have not yet connected speakers to your SOUND HUB, please do so as described in [Section 3.3 / page 12](#).

NOTE:

You may need to configure the settings of your TV to use external speakers. Refer to the TV user manual to find out how to do this.

NOTE:

You may need to configure the settings of your TV to use HDMI-CEC. Implementation of CEC will enable the TV remote control to control SOUND HUB volume, mute and standby functions.

8. Installing and Using the SOUND HUB HDMI Module

8.2 Configuring Your HDMI Equipped SOUND HUB

In addition to Speaker Balance Adjustment (see [Section 5.8 / page 29](#)) and Speaker Distance Adjustment (see [Section 5.8 / page 29](#)), two further HDMI module options that are particularly relevant for multi-channel systems can be configured by switches on the HDMI module. The switches are illustrated in [Diagram D 12 / page 52](#), and their options are described in the following paragraphs.

Upmix HDMI To All Speakers

The “Upmix HDMI To All Speakers” switch configures how an HDMI module equipped SOUND HUB treats programme material encoded with fewer channels than there are speakers connected. Example: The programme material playing via the HDMI module is stereo (2.0), yet the SOUND HUB has five speakers and a subwoofer connected (5.1).

If the “Upmix HDMI To All Speakers” switch is set to YES, audio material will be routed appropriately to and played by all the connected speakers. The SOUND HUB will intelligently decide on the appropriate signal routed to each speaker.

NOTE:

Regardless of the HDMI upmix option selected, when either a wired or wireless subwoofer is connected, SOUND HUB bass management will automatically ensure that the appropriate signal is routed to the subwoofer – taking into account both audio formats and connected DALI speaker models.

8. Installing and Using the SOUND HUB HDMI Module

8.2 Configuring Your HDMI Equipped SOUND HUB

If the “Upmix HDMI To All Speakers” switch is set to NO, audio material encoded for fewer channels than there are speakers will be routed to and played by only the speaker channels for which it is encoded. Other speakers will be muted. For example, if audio material encoded for 5.1 is played on a 7.1 speaker SOUND HUB system the two rear surround speakers will remain silent.

We recommend that the “Upmix HDMI To All Speakers” switch is set to YES **A** unless there are specific reasons why you wish to use the alternative option.

- Due to specific media encoding attributes it is sometimes possible for multi-channel material not to utilise all connected speakers, even with the “Upmix HDMI To All Speakers” option engaged. If this occurs, you may find that configuring your SOUND HUB to employ the simpler Dolby ProLogic I post-processing technology, rather than its default ProLogic II, may result in full speaker utilisation. To configure your SOUND HUB to use ProLogic I, press and hold the front panel Mute button while the HDMI input is selected. Now turn the Volume Control to select “P1” for ProLogic I or “P2” for ProLogic II. Release the Mute button when the required option is selected. Remember to re-set the SOUND HUB to ProLogic II when ProLogic I is no longer required.

D 12: HDMI module switches

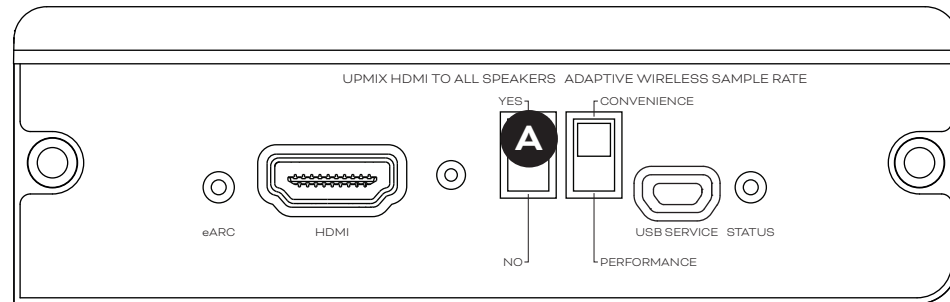

8. Installing and Using the SOUND HUB HDMI Module

8.2 Configuring Your HDMI Equipped SOUND HUB

Adaptive Wireless Sample Rate

The “Adaptive Wireless Sample Rate” switch **B** configures how your HDMI module equipped SOUND HUB handles the digital sample rate of multi-channel audio.

If the Adaptive Wireless Sample Rate switch is set to CONVENIENCE, audio from any source will be broadcast by the SOUND HUB to all connected wireless speakers at 16bit/48kHz digital resolution. If the Adaptive Wireless Sample Rate switch is set to PERFORMANCE, while HDMI audio will continue to be broadcast at 16bit/48kHz resolution, audio from other SOUND HUB sources will be broadcast at higher, 24bit/96kHz, resolution. In systems including only stereo speakers, audio will always be broadcast in 24bit/96kHz resolution, regardless of the setting of the switch.

We recommend that the Adaptive Wireless Sample Rate switch is set to CONVENIENCE unless there are specific reasons why you wish to use the 24bit/96kHz option on non HDMI source material. The reason for this recommendation is that in PERFORMANCE mode the SOUND HUB needs to implement sample rate switching when selecting or deselecting the HDMI input and this results in a noticeable switching delay.

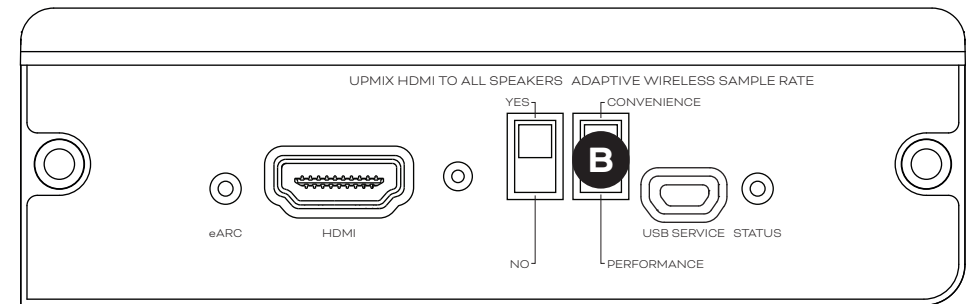

8. Installing and Using the SOUND HUB HDMI Module

8.3 Using Your HDMI Equipped SOUND HUB

With your SOUND HUB HDMI module installed, configured and connected to a TV ARC or eARC HDMI socket, you will be able to enjoy uncompressed PCM audio as well as Dolby Digital and DTS encoded multi-channel audio from up to seven wireless speaker channels and one wireless subwoofer channel. The full range of multi-channel SOUND HUB HDMI compatible encoding formats, together with their speaker channel complements is listed in table [T3](#).

The SOUND HUB HDMI module will automatically identify the encoding format of any HDMI signal, decode it appropriately and route it to the appropriate speaker channels. If the SOUND HUB HDMI upmix function is engaged, material encoded for fewer speakers than are available will be intelligently distributed to all speaker channels. The encoding and channel formats of HDMI material will be briefly shown sequentially on the SOUND HUB display when the HDMI input is selected, as well as whenever the format changes.

The SOUND HUB HDMI input is included in the SOUND HUB Auto Signal Sensing functions and will be selected automatically when the TV is switched on if no other SOUND HUB input is active at the time.

NOTE:

If the SOUND HUB display shows “PCM” when a multi-channel HDMI signal is selected, this indicates that Dolby or DTS decoding has been implemented internally by the source TV and that multiple individual audio channels are being delivered to the SOUND HUB. Due to variations in TV decoding performance however we recommend that Dolby and DTS decoding is best handled by the SOUND HUB. To disable TV decoding, open the TV setup menus and switch off any internal multi-channel decoding options. If in doubt, refer to the TV user manual.

8. Installing and Using the SOUND HUB HDMI Module

8.3 Using Your HDMI Equipped SOUND HUB

The input encoding format received by the HDMI module will be shown as either PCM, Dolby or DTS, as illustrated below.

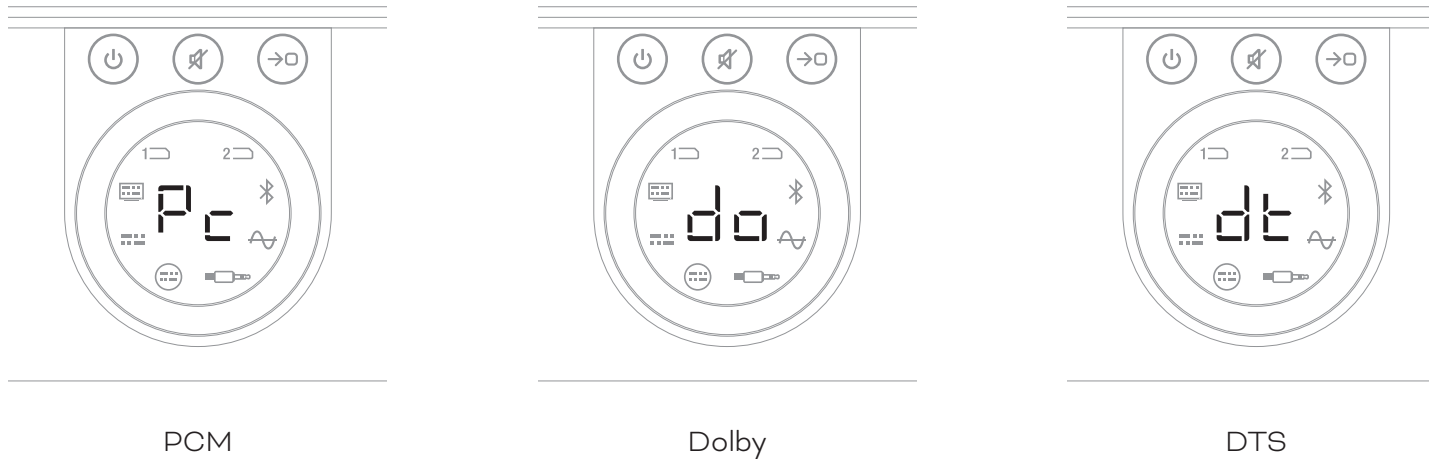

The post-processing of the HDMI module depends on the input encoding format. Dolby will be post-processed by the Dolby ProLogic I or Dolby ProLogic IIx codec, depending on user selection, while DTS and PCM will be post-processed by the DTS Neo:6 Cinema codec.

8. Installing and Using the SOUND HUB HDMI Module

8.3 Using Your HDMI Equipped SOUND HUB

T3: Valid Multi-Channel Speaker Arrangements

Format	Left Front	Right Front	Centre	Left Surround	Right Surround	Left Rear Surround	Right Rear Surround	Sub
2.0	✓	✓						
2.1	✓	✓						✓
3.0	✓	✓	✓					
3.1	✓	✓	✓					✓
4.0	✓	✓		✓	✓			
4.1	✓	✓		✓	✓			✓
5.0	✓	✓	✓	✓	✓			
5.1	✓	✓	✓	✓	✓			✓
6.0	✓	✓		✓	✓	✓	✓	
6.1	✓	✓		✓	✓	✓	✓	✓
7.0	✓	✓	✓	✓	✓	✓	✓	
7.1	✓	✓	✓	✓	✓	✓	✓	✓

NOTE:

Depending on the number of wireless speakers available to an HDMI module equipped SOUND HUB there is a limited range of valid multi-channel speaker layouts. These layouts are specified in the adjacent table. If an invalid speaker setup is connected, the SOUND HUB will intelligently combine the audio for any missing channels into the signal routed to the most appropriate speaker or speakers.

8. Installing and Using the SOUND HUB HDMI Module

8.3 Using Your HDMI Equipped SOUND HUB

NOTE:

When playing DTS 7.x and PCM 7.x material on a 6.0 or 6.1 speaker system, the same audio signal will be routed to each pair of rear and side surround speakers. Dolby Surround 7.1 material is not limited in this respect.

NOTE:

When playing PCM 5.x material on a system with more speakers, the audio will not be upmixed.

NOTE:

The SOUND HUB allows ten speakers in total to be connected wirelessly. This potentially enables, for example, multiple stereo left and right channel speakers, duplicate surround speakers or perhaps twin subwoofers to be used in a multi-channel system.

9. Technical Specifications

DALI SOUND HUB		NPM-2i		HDMI	
Input Connections	2 × Optical (TosLink), Coax (S/PDIF), RCA (Analogue stereo), 3.5 mm Stereo (mini-jack), 2 × Plug-in module	General		Supported Audio Formats	Linear PCM (up to 7.1ch/24 bit/192 kHz) Dolby TrueHD (up to 7.1ch) DTS HD Master Audio (up to 7.1ch) DTS HD High-resolution Audio (up to 7.1ch) Dolby Digital (up to 5.1ch) Dolby Digital Plus (up to 7.1ch) DTS LBR (up to 5.1ch) DTS ES/Extended Surround (up to 6.1ch)
Input Impedance RCA [Ω]	10k	Operating System	BluOS	Multichannel Decoding	Up to 7.1
Input Sensitivity RCA [V]	2.3	Supported Operating Systems	iOS, Android, Windows Vista, 7, 8, 10, macOS X 10-11	Sample Rate	48 kHz
Input Impedance 3.5mm mini-jack [Ω]	10k	Supported File Formats	MP3, AAC, WMA, WMA-L, OGG, FLAC, ALAC, WAV, AIFF, MQA 32	Bit Depth	24
Input Sensitivity 3.5mm mini-jack [V]	1.2	Native Sampling Rates	192 kHz	Connectors and features	
Input Impedance S/PDIF [Ω]	75	Bit Depths	16 - 24	Back Panel Indicators	Module Status, eARC status
Output Connections	Stereo Line level (RCA), Sub-out (RCA), USB Charge (5V/1A)	Music Service Integrations	17+	Input Connector	HDMI
Output Voltage Max. Line Level [V]	1.9	3rd-Party Integrations	Apple AirPlay 2	Service Connector	USB Type B for product servicing
Output Voltage Max. Sub-Out [V]	0.9	Control System Integrations	Crestron, Control 4, RTI, ELAN, URC, Push, Lutron, iPort Supports	Edge Connector	70 pin
Maximum digital resolution [bits/kHz]	24 / 96	Voice Control Integrations	Amazon Alexa Skills, Works with Google Assistant Skills	Power Consumption (Idle)	Standby: 250 mW Max. active: 2.5 W
Wireless Input	Bluetooth 4.2 (AAC, Apt-X, Apt-X HD)	Features		Finish	Black
Wireless Output	Full 24 Bit / 96 kHz (No bit-loss attenuated)	Back Panel Status	LED	Dimensions (H × W × D) [mm]	155 × 114 × 36
Input mains	Universal AC Mains Adapter (1.75 m wire length)	Processor	ARM® Cortex™ -A9, 1 GHz	Dimensions (H × W × D) [Inches]	6.1 × 4.9 × 1.4
Maximum Power Consumption [W]	4.5	Updates	Over the air	Weight	0.22 kg / 0.5 lbs
Standby Power Consumption [W]	2.5	Discovery Protocols Supported	Bonjour, MDNS, LSDP		
Dimensions (H × W × D) [mm]	76 × 300 × 213	Connections			
Dimensions (H × W × D) [Inches]	3.0 × 11.8 × 8.4	Ethernet/LAN	Ethernet RJ45, 100 Base-T		
Weight	1.6 kg / 3.2 lbs	WiFi (External USB Accessory)	802.11 b/g/n WiFi		
Accessories Included	Quick Setup Guide	USB IN × 2	Type A (FAT32 or NTFS-formatted)		
		USB	Type B (mini) for product servicing		
		Edge Connector	70 pin		
		Power Consumption (Idle)	3 W		
		Finish	Black		
		Dimensions (H × W × D) [mm]	155 × 114 × 36		
		Dimensions (H × W × D) [Inches]	6.1 × 4.9 × 1.4		
		Weight	0.22 kg / 0.5 lbs		

All technical specifications are subject to change without notice.



10. Diagrams / Tables

Diagrams

D 1: SOUND HUB Rear Panel	5
D 2: SOUND HUB Front Panel	6
D 3: Remote Control	7
D 4: Setups	8
D 5: In the box	9
D 6: Inserting batteries	11
D 7: Connecting Speakers	14
D 8: Multi-Channel Home Theatre System	15
D 9: NPM-2i module rear panel	41
D 10: HDMI module rear panel	47
D 11: HDMI module	50
D 12: HDMI module switches	52

Tables

T 1: Speaker channel assignments	12
T 2: LED Blink Codes	43
T 3: Valid Multi-Channel Speaker Arrangements	56

