



# Tambaqui

*the DAC that stands alone*



## User's Manual

### **Mola Mola**

Kattegat 8  
9723 JP Groningen  
The Netherlands  
+31 50 526 4993  
info@mola-mola.nl  
www.mola-mola.nl

Please read this manual before operating the unit

### Packing List

Your product was shipped with the items checked below. Please verify that you find all items mentioned in this list before you start setting up:

Item	Qty	Shipper's signature
Tambaqui	1	
Power Cord	1	
XLR/RCA adapter	2	
Standard Remote Control Unit		
Premium Remote Control Unit		

This Mola Mola product has no user serviceable parts inside. Opening and/or making changes to the unit by any other than Mola Mola approved service engineers voids the warranty.

**CAUTION:** Absolutely only select Direct if the Tambaqui is connected to a volume controlled preamplifier or integrated amplifier. Direct mode is equivalent to turning the volume all the way up. Engaging Direct mode with the Tambaqui connected directly to a power amp or monoblocks may damage your loudspeakers.

## Welcome

First off, congratulations! With the purchase of this product you have joined a growing community of audiophiles who value truthful sound reproduction and who consider neutral and transparent electronics a cornerstone in this pursuit. We at Mola Mola made it our primary goal to build electronics capable of passing a signal with no discernible change at all. Amplifiers make the signal bigger, converters turn the signal from a digital representation into an analogue one. In all these processes we strive to add nothing and to remove nothing.

Through our work designing professional audio equipment we have collected extensive knowledge of how to achieve total freedom from colouration without having to resort to minimalist circuitry. This allows us to build products that are purist without cutting back functionality.

The 4 preset buttons are programmable via the Mola Mola Remote app to access any combination of source, processing and routing.

We wish you a lifetime of musical enjoyment with this product and thank you for your custom.

Mola Mola Team

## Table of contents

Important Safety Instructions .....	1
Connections & Controls .....	3
Front .....	3
Rear .....	4
Digital sources .....	5
Setting Up .....	6
Installation .....	6
Connection .....	6
Basic operation .....	8
Factory Preset Mode .....	8
Front Panel Operation .....	8
Premium IR Remote Control Operation .....	10
Standard IR Remote Control Operation .....	10
Android® and iOS® .....	10
The Mola Mola remote .....	11
Roos .....	23
Drivers and updates .....	25
Troubleshooting .....	26
Audio performance data .....	27
Technical data .....	28
Annex I: RC5 Codes .....	29
Annex II: Standard Remote Control Unit .....	30
Revision History .....	31

## List of tables

Table 1: Front panel overview.....	3
Table 2: Rear panel overview .....	4
Table 3: Digital source overview.....	5
Table 4: HDMI pinout.....	5
Table 5: Audio Performance Data .....	27
Table 6: Technical Data .....	28
Table 7: RC5 Codes.....	29

## List of figures

Figure 1: Front panel overview.....	3
Figure 2: Rear panel overview .....	4
Figure 3: Mute and source shown on display.....	9
Figure 4: Volume and source shown on display. ....	9
Figure 5: Pull down to scan for devices.....	11
Figure 6: Discovered devices. ....	11
Figure 7: Type in new name and click Add device. ....	12
Figure 8: The start-up page. ....	12
Figure 9: Swipe left to show disconnect and remove buttons. ....	13
Figure 10: Home Page, Preset 1 is selected, headphones are off.....	14
Figure 11: Forced headphones enabled .....	15
Figure 12: Preset Page for Preset 1. ....	16
Figure 13: Direct mode enabled.....	18
Figure 14: About Page. ....	19
Figure 15: Update Page.....	22
Figure 16: The Tambaqui will show up on the Audio settings page in Roon.....	23
Figure 17: Fill in Zone Name .....	23
Figure 18: Click on Configure Device to go to the Tambaqui webpage .....	24
Figure 19: The Tambaqui webpage.....	24
Figure 20: Firmware update tool. ....	25

## Important Safety Instructions

Throughout this document, some aspects of operation that have a potential impact on safety or reliability are noted with the words “Warning” and “Caution”. Take particular care reading and understanding these items. Paragraphs marked with “Warning” explain safety measures required to maintain your personal safety. Paragraphs marked with “Caution” pertain to danger to the equipment itself or to connected equipment. Please follow these precautions when using this product:

1. Read these instructions.
2. Keep these instructions.
3. Follow all instructions.
4. Heed all warnings.
5. Install in accordance with the manufacturer's instructions.
6. Use only attachments or accessories specified by the manufacturer.
7. **WARNING:** Dangerous voltage is inside this apparatus. Opening is only allowed by qualified service personnel.
8. **WARNING:** Do not defeat the safety purpose of the safety earth connection. Use the provided three-prong power cord to ensure the product is connected to safety earth. If the provided mains cord does not fit your outlet, consult an electrician for replacement of the obsolete outlet.
9. Protect the power cord from being walked on or pinched, particularly at plugs, convenience receptacles, and the point where they exit from the apparatus.
10. Unplug this apparatus during lightning storms or when unused for long periods of time.
11. **WARNING:** Do not use this apparatus near water. Do not expose the apparatus to dripping or splashing. Do not place objects filled with liquids (flower vases, drink cans, coffee cups, etc) on the apparatus. Do not use this apparatus out of doors.
12. **WARNING:** Clean only with a dry, soft, lint-free cloth. Do not spray any liquid cleaner onto the cabinet, as this may lead to dangerous shocks or malfunction.
13. **CAUTION:** This device runs slightly warm when operated normally. Operate in a normally ventilated area.

14. **CAUTION:** Do not install near any heat sources such as radiators, heat registers, stoves, or other apparatus (including amplifiers) that produce heat. Avoid exposure to direct sunlight.
15. Use only with a cart, stand, bracket, or table designed for use with audio or music equipment. In any installation, make sure that injury or damage will not result from cables pulling on the apparatus and its mounting.
16. Refer all servicing to qualified service personnel. Servicing is required when the apparatus has been damaged in any way, such as when the power-supply cord or plug is damaged, liquid has been spilled or objects have fallen into the apparatus, the apparatus has been exposed to rain or moisture, does not operate normally, or has been dropped.
17. **WARNING:** To reduce the risk of fire or electric shock, do not expose this apparatus to rain or moisture.

## Connections & Controls

### Front

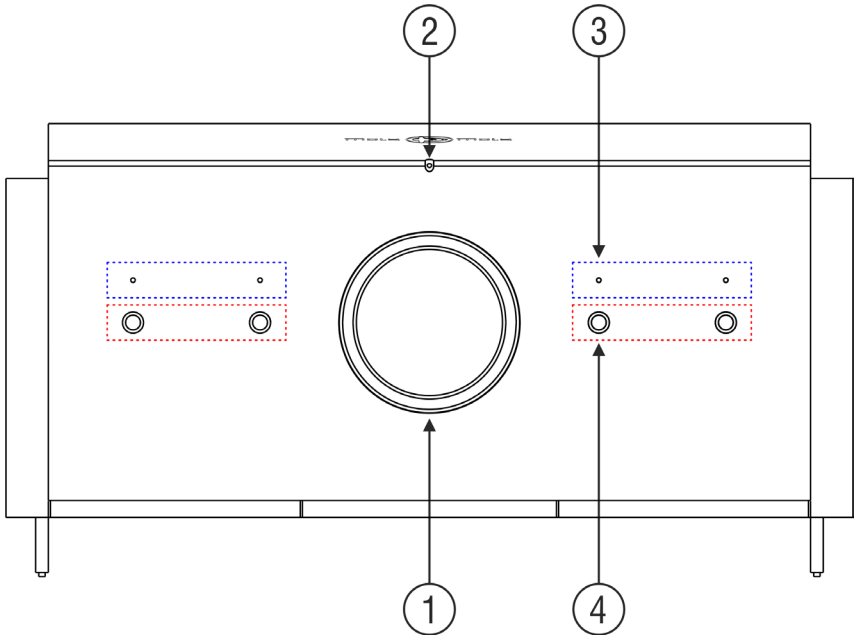

Figure 1: Front panel overview

#	Function	Notes
1	Display	
2	Power LED	1 LED, white or dim red
3	Preset indicator LED	4 LEDs, white
4	Presets	4 push buttons

Table 1: Front panel overview



**Rear**

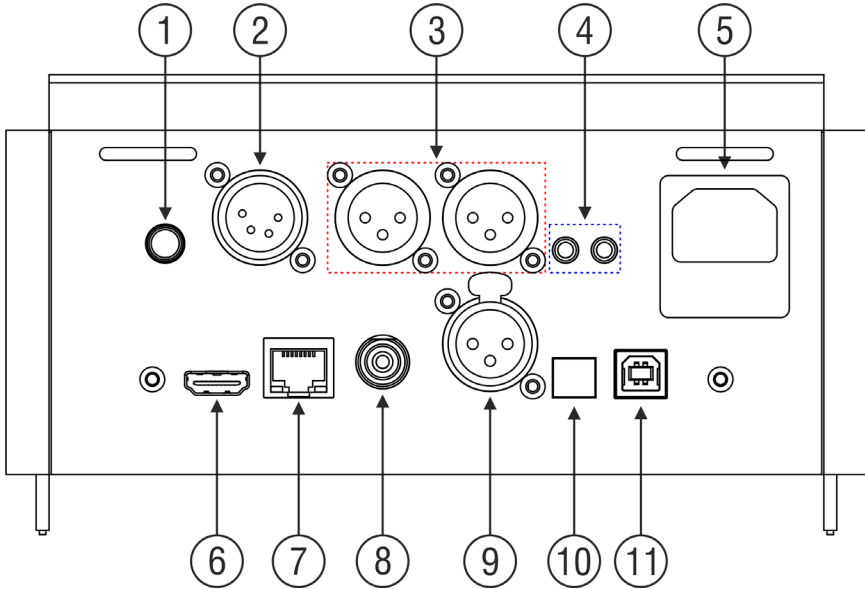

Figure 2: Rear panel overview

#	Function	Notes
1	Headphone jack, 6.3mm	
2	Headphone XLR4	
3	Analogue Outputs	1 stereo pair
4	Trigger Outputs	2 programmable outputs
5	Mains power input	
6	I2S over HDMI	See table 4 for HDMI pinout configuration
7	Network	
8	S/PDIF	
9	AES/EBU	
10	Optical (Toslink)	
11	USB type B	USB audio + firmware updates

Table 2: Rear panel overview

## Digital sources

The Tambaqui contains 7 digital audio inputs: USB, Optical (Toslink), S/PDIF, AES/EBU (XLR), Network, I2S over HDMI and Bluetooth (SBC, AAC, APTX, LDAC).

The supported formats are shown in Table 3.

Only the USB and Network inputs support the playback of DoP (DSD over PCM) and Native DSD. Native DSD is not supported with the Mola Mola USB-Audio Driver for Windows.

MQA is not supported.

A resync delay of 1 second is recommended for playback of DSD files.

#	Function	PCM support	DSD support
1	USB type B	Up to 384 kHz / 32 bits	DoP: up to DSD256 Native: up to DSD256
2	Optical (Toslink)	Up to 192 kHz / 24 bits	No
3	AES/EBU	Up to 192 kHz / 24 bits	No
4	S/PDIF	Up to 192 kHz / 24 bits	No
5	Network	Up to 384 kHz / 32 bits	DoP: Up to DSD256 Native: Up to DSD256
6	I2S over HDMI	Up to 192 kHz / 24 bits	No
7	Bluetooth	48 kHz / 16 bits	No

Table 3: Digital source overview

Pin	Connection
1	SDATA - (Serial data)
3	SDATA + (Serial data)
4	SCLK + (Bit clock)
6	SCLK - (Bit clock)
7	LRCLK - (Word clock)
9	LRCLK + (Word clock)
10	MCLK + (Master clock)
12	MCLK - (Master clock)
2, 5, 8, 11, 17, 19, 20	GND
13, 14, 15, 16, 18	Not Connected

Table 4: HDMI pinout

## Setting Up

### *Installation*

This product relies on free convection of air along the sides and top for cooling. Avoid placing magazines, books or other objects on top of the product as this acts as thermal insulation. Installation inside a cupboard is permissible provided at least 30cm (12") of free space above the product and 10cm (4") around the sides is respected. Operation in closer quarters requires some provision of forced convection (fan) to be installed inside the cupboard.

### *Connection*

---

**CAUTION: Whenever you are plugging or unplugging cables, make sure that the device is turned off. Failure to take this precaution may result in pops or bangs in the loudspeaker. Use properly shielded interconnects with reliable connectors.**

---

#### *AC Power Input*

Connect the supplied power cord to the AC input receptacle on the rear panel. Do not connect the power cord until all the audio input and output connections have been made.

It is usually best to plug the product directly into a wall outlet. Avoid the use of extension cords. A heavy duty multi-tap power outlet strip may be used if it and the wall outlet are rated to handle the total current demanded by the components connected to it.

Your Tambaqui has a universal input power supply, allowing it to operate anywhere from 90V to 240V mains.

If you are going to be away from home for an extended period of time such as a month-long vacation, it is a sensible precaution to unplug electronic equipment. Do the same as a precautionary measure during thunderstorms. No amount of surge protection or mains filtering will save your equipment from a lightning strike in the backyard.

#### *Output connections*

The Tambaqui has one pair of XLR outputs. If you need RCA outputs to interface with a pre amp or power amp that lacks balanced inputs, most commonly available adapter cables or plugs will work fine. Keep in mind that pin 2 is hot (signal) and pin 3 carries the reference potential (cold).

### ***Headphones connections***

There are two headphone connections available:

- XLR4
- Stereo jack, 6.35 mm

Keep in mind that pin 1 (left) & 3 (right) of the XLR4 connector are hot (signal) and pin 2 (left) & 4 (right) carries the reference potential (cold).

### ***Trigger outputs***

The two 12VDC trigger outputs can be used for various purposes. The most obvious one is making the power amplifier turn on and off with your Tambaqui. Another is making an external preamplifier turn on and off if you choose to use the Tambaqui in Direct mode. Any standard 3.5mm jack/jack cable will do (mono or stereo). Although the factory setting is to make all 2 outputs come on as soon as the Tambaqui is turned on, they can be linked to individual presets.

## Basic operation

### ***Factory Preset Mode***

Your Tambaqui comes factory-programmed with default settings. In this mode:

- The leftmost button selects the network source (source 1)
- Preampifier volume is set at -50 dB.
- Headphone volume is set at -50 dB.
- The trigger outputs are always on.
- Headphones are disabled.
- Direct mode is disabled.

Should you wish to return your Tambaqui to its factory-programmed state, you can do so by holding down the two buttons on the outside (Preset 1 & Preset 4) for one second or more until the display will show the message: Restore Default Presets. It makes good sense to do this if this is a device you are loaning for evaluation and it was sent to you directly by a previous user.

### ***Front Panel Operation***

#### ***Powering Up***

So long as mains power is applied the power LED can be in two states: on or standby. In standby mode it will light up a dim red (barely visible in daylight, bright red standby LEDs lighting up the room at night is a pet peeve of the designer). Push any of the 4 buttons to wake up the Tambaqui. The power LED lights up white and the preset you have just pushed will be engaged (as indicated by the LED above the button). After powering up the Tambaqui is muted for 30 seconds to allow the DAC to start up. Detection of the network source and USB source may take up to 60 seconds. The LED of the selected preset will blink but the display will show the volume.

#### ***Selecting Inputs***

The preset indicator LED lights up solid when the Tambaqui is passing signal and blinks when it is muted.

### ***Muting***

You can also make your Tambaqui mute by pushing the currently selected preset button. The volume will ramp down fast to silence. When the Tambaqui is muted the display will show the message as shown in figure 3. Push again or change the volume to unmute.

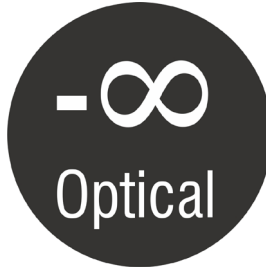

*Figure 3: Mute and source shown on display.*

### ***Display***

The display will show the current volume and the selected source. 15 minutes after the last change on the display, it will turn off. The display will turn on again when the volume or source changes.



*Figure 4: Volume and source shown on display.*

### ***Powering Down***

You can turn the Tambaqui off (place in standby mode) by holding any of the 4 buttons until the device powers down (about 1 second).

## ***Premium IR Remote Control Operation***

The group of six buttons on the remote control mirrors the front panel buttons. Pushing any of them **will power the device on and/or** engage the associated preset and/or mute the unit. Button 5 and 6 do not correspond to a preset. The top button acts as mute/standby button **and does the exact same as the preset buttons except it does not switch presets.** This is mainly useful because the remote control unit obviously does not have LEDs to indicate which preset is engaged and sometimes you just want to mute the device regardless of what was playing. The volume up/down buttons operate as they do anywhere else.

## ***Standard IR Remote Control Operation***

The standard-issue RC unit works slightly different. The button in the middle of the quadrants turns the Tambaqui on or off (hold 1 second for off). Press this button once for mute or unmute. Pushing on the left and right quadrants of the ring cycles through the 4 presets. The top and bottom quadrants control the volume. The two lower buttons are not used.

## ***Android® and iOS®***

Your Tambaqui is fitted with a Bluetooth® module to allow access with a mobile device. To use this feature, install the Mola Mola remote app from the App Store or Play store.

The home page shows the preset buttons and volume control. Other pages are used for advanced control and programming. They are explained in the Mola Mola remote section.

## ***Powering Up and Down***

The stand-by logo in the top left corner acts as power button.

## ***Volume control***

Move the slider at the bottom of the home page to change volume. The + and – buttons can also be used to adjust the volume in small steps. Click on the speaker indicator to mute or unmute.

## ***Mute***

Click on the speaker indicator to mute or unmute. The speaker indicator and volume slider bar will turn red when muted.

## The Mola Mola remote

The control app for your Tambaqui is available in the [Apple App store](#) and [Google Play store](#). The app can be used for all Mola Mola products. The app will attempt to contact your Tambaqui and should find it as long as it is within reach and plugged in. Also ensure that the Bluetooth function of your mobile device is enabled. The app will auto connect when there is only one Mola Mola device paired with the app. The app will turn the Tambaqui on during the connection procedure when it is not already turned on. In case you have multiple Mola Mola devices select the device you wish to operate and click on Choose device.

First time setup:

1. Pull down to scan for devices (figure 5).
2. Click on the Add button of the device you want add (figure 6).
3. Type in new name and click Add device (figure 7).
4. Connect with device by clicking on Choose device at the bottom of the page (figure 8).

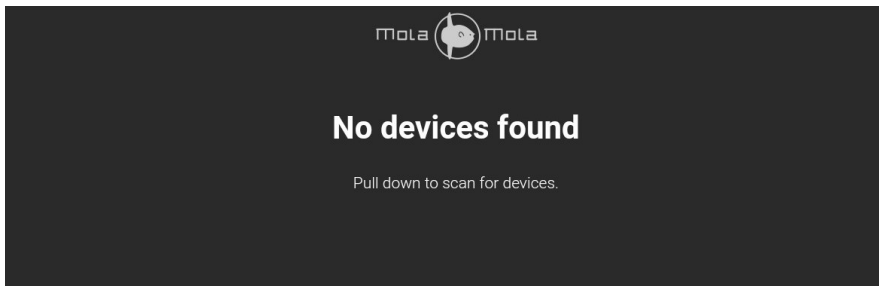

Figure 5: Pull down to scan for devices.

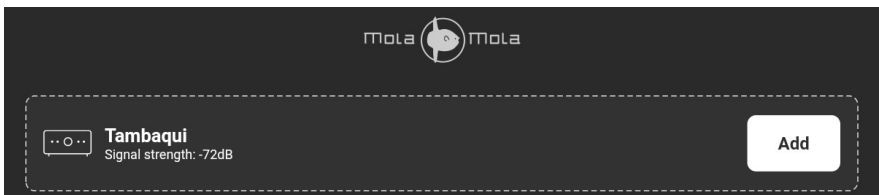

Figure 6: Discovered devices.



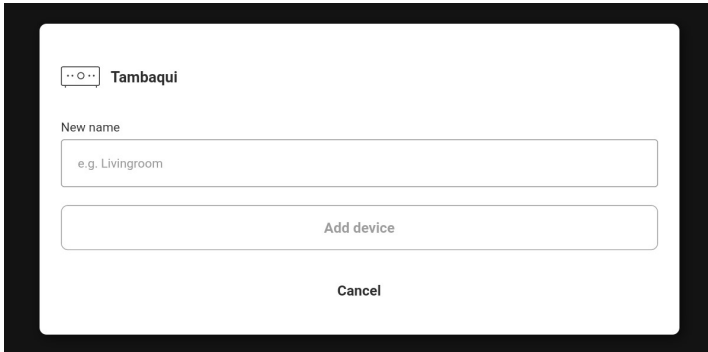

Figure 7: Type in new name and click Add device.

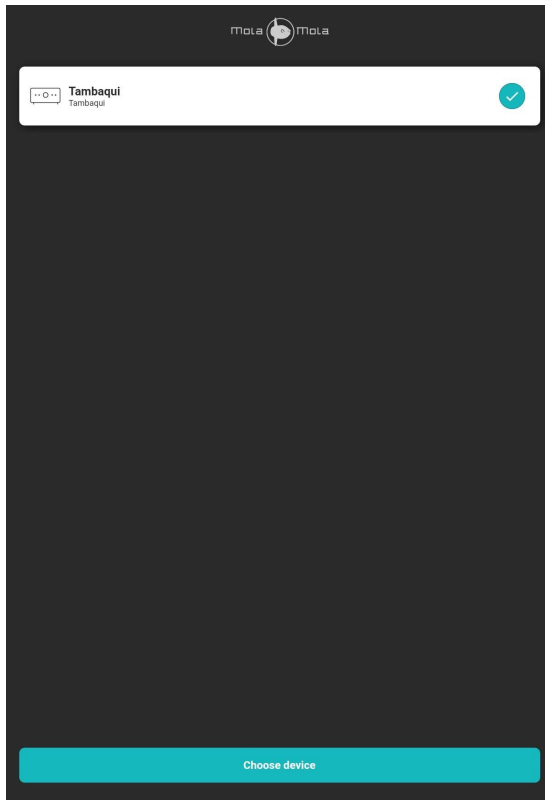
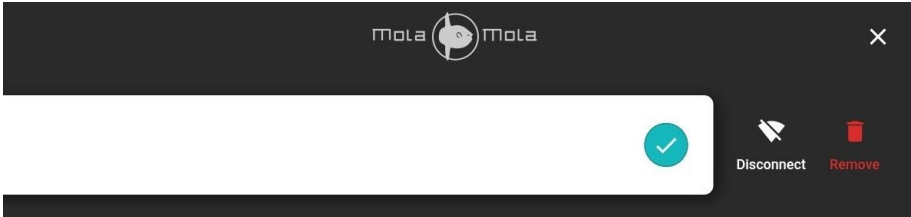

Figure 8: The start-up page.

Swiping a device to the left will allow you to remove the device from the Mola Mola remote app by clicking on the remove button. If the device is already connected with the app then an disconnect button is also shown here (figure 9).



*Figure 9: Swipe left to show disconnect and remove buttons.*

## Home Page

The home page is the regular remote control, as outlined in the section about basic operation. Move the slider at the bottom of the home page to change volume. The + and – buttons can also be used to adjust the volume in small steps. Click on the speaker indicator to mute or unmute.

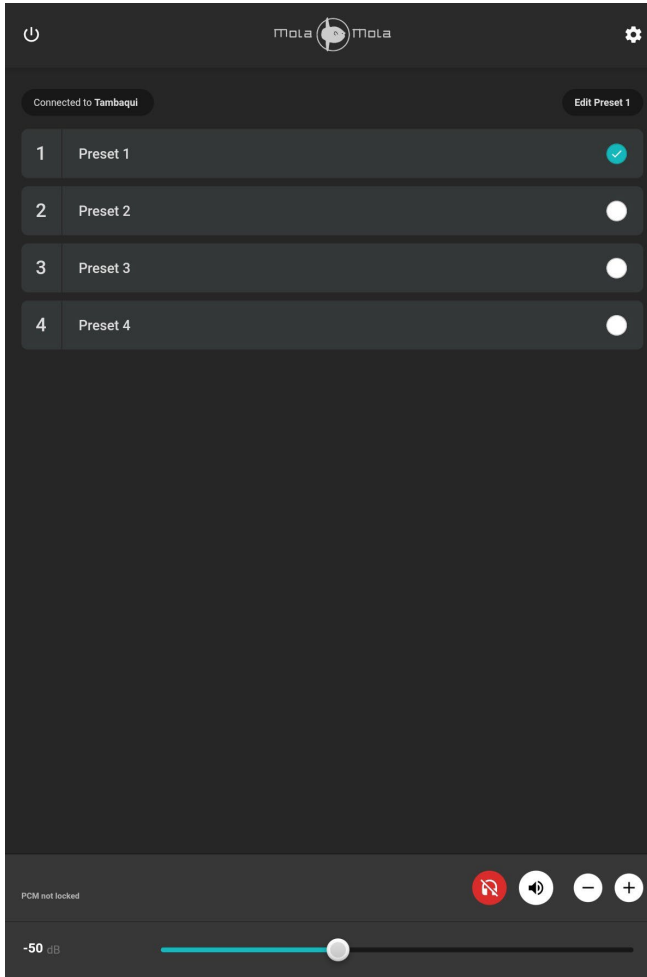
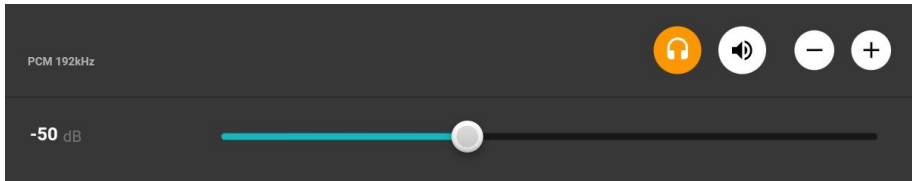

Figure 10: Home Page, Preset 1 is selected, headphones are off.

Next to the speaker indicator is the headphone button. This symbol will be white when the headphones are enabled when Headphones are selected under routing on the preset page.

Forced headphone mode is activated by clicking on the Headphone button on the home page. When the forced headphones mode is enabled, Headphone mode is active for all presets regardless of the routing settings on the preset page. The headphone button is orange when forced headphone mode is enabled. Disabling the forced headphone mode will restore the routing mode of the selected preset. The Tambaqui always powers up with forced headphone mode disabled. Forced headphone mode is supported when the firmware version is 1.5 or higher.



*Figure 11: Forced headphones enabled*

The home page will show the status of the DAC in the lower left corner. Input type shows the incoming audio format, PCM or DSD. Sample rate shows the sample rate of the incoming audio.

To program a preset, tap the button of the preset you want to change and click on the edit preset button in the top right corner.

## Preset Page

On this page you can change the settings for the selected preset. It will display the settings of the preset currently in use. To change the source, click on the current source. Select the desired source in the dropdown menu.

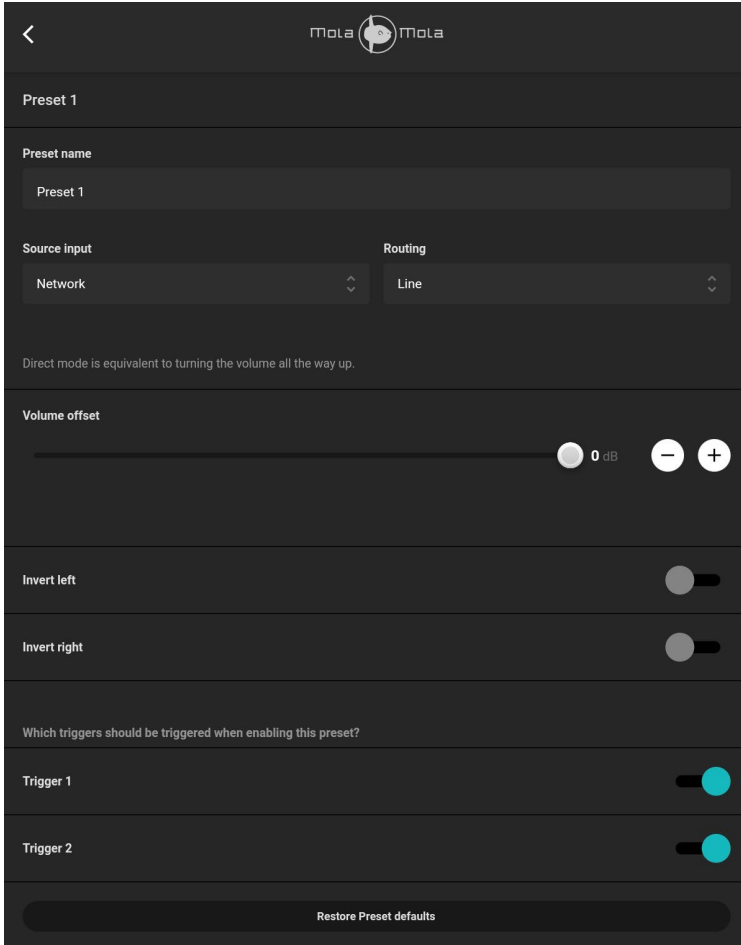

Figure 12: Preset Page for Preset 1.

You can edit the name of the preset. Wait until the check appears in the right corner of the Preset name field. The new name will automatically be shown on the home page buttons. The maximum length of a preset name is nine characters.

### **Preamplifier mode**

Preamplifier mode is enabled by default. In this mode the digital volume control is enabled so that you can connect the Tambaqui directly to a power amplifier. This mode is enabled by selecting Line under Routing. The volume can be changed with a remote or the Mola Mola remote app.

### **Direct mode**

This mode is enabled by selecting Direct under Routing. Direct mode disables the volume control. This mode should only be used when the Tambaqui is connected to an external preamplifier with a volume control. The display will show "Direct" instead of the volume. The volume control in the Mola Mola remote is disabled. There is a notification that Direct mode is enabled.

---

**CAUTION: Absolutely only select Direct if the Tambaqui is connected to a volume controlled preamplifier or integrated amplifier. Direct mode is equivalent to turning the volume all the way up. Engaging Direct mode with the Tambaqui connected directly to a power amp or monoblocks may damage your loudspeakers.**

---

### **Headphone mode**

Headphone mode is activated by selecting Headphone on the preset page. When the headphones are enabled the volume is set to the last used volume in Headphone mode. Disabling the headphones will restore the last used volume in Preamplifier mode.

### **Level offset**

Level offset subtracts a fixed amount to the volume whenever this preset is active. Use this when you find that you always have to turn the volume up or down compared to other sources. It can also be used to match the line level of the Tambaqui with other sources connected to your external preamplifier. Level offset is effective in preamplifier mode, direct mode and headphone mode.

### **Polarity invert**

The two polarity invert buttons invert the polarity (absolute phase) of the left and/or right channel.

## Triggers

The two trigger buttons correspond to the two trigger outputs on the rear panel. They are always on by default, which is the best setting if you only use them to turn your power amplifiers on. If you have selected the headphone mode then the trigger outputs are automatically disabled.

## Restore Preset defaults

Pressing this button will only restore the current preset to its default settings. Global settings such as preamplifier volume, headphone volume and balance will not be changed. This functionality is supported when the firmware version is 2.1 or higher.

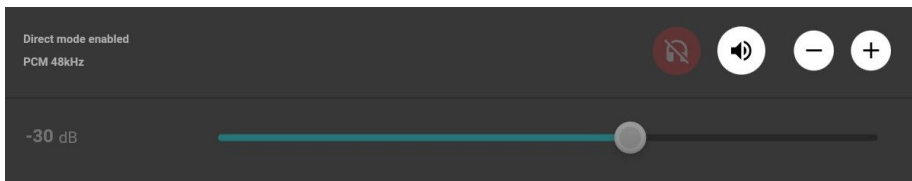

*Figure 13: Direct mode enabled*

### About Page

Clicking on the gear symbol in the top right corner of the home page will direct to the About page.

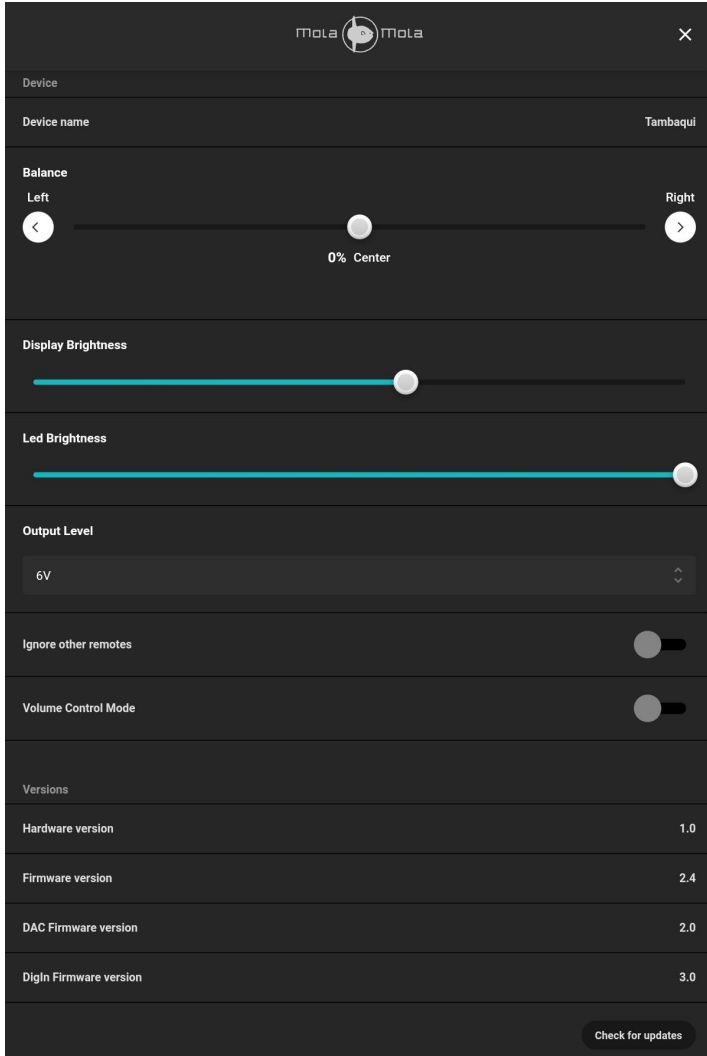

Figure 14: About Page.



## Balance

Balance is not normally needed unless an acoustic oddity or asymmetrical speaker placement consistently pull the sound stage off centre. Double tap on the circle will center the balance.

## Display Brightness

The brightness of the display is user adjustable. Slide the slider completely to the left to turn off the display.

## LED Brightness

The LED brightness of the preset LED and the power LED is user adjustable with front firmware version 2.4 or higher. The LEDs are set to maximum brightness by default. The LED brightness slider has 4 positions. Sliding the slider completely to the left will turn off the preset LED and the power LED is set at minimum brightness.

## Maximum Output Line levels

Adjust the maximum output line level in case you hear clipping when the Tambaqui is connected to a preamplifier. Some preamplifiers cannot handle a line level input of 6V RMS. Selecting a line level output of 2V RMS is sufficient to solve this issue. It can also be used to match the line level with other sources connected to your external preamplifier.

In case you have connected the Tambaqui directly to your amplifiers you could choose a lower output level to prevent accidentally high output levels.

This setting does not affect headphone output levels.

There are 3 options for output levels:

1. **6V**      Default setting
2. **2V**      -10dB attenuation
3. **0.6V**    -20dB attenuation
- 4.

## Ignore other remotes

When Ignore other remotes is enabled then the Tambaqui will not respond to IR remote commands that are preceded with IR device address 16. The Tambaqui will only respond only to IR remote commands that are preceded with IR device address 18. This can be useful when the Tambaqui responds undesirably to an IR remote control of another device. The Premium IR Remote and the Standard IR Remote both use IR device address 16. The Tambaqui will not respond to those IR remote controls when Ignore other remotes is enabled. This functionality is supported when the firmware version is 2.1 or higher.

## Volume control mode

The volume can be controlled with the front buttons when volume control mode is enabled. The front buttons will only function as preset buttons during standby. When the Tambaqui is in standby mode you can power on the device with a preset of your choosing by pushing down the corresponding preset button. The selected preset is indicated by the corresponding preset indicator LED.

When the device is powered, you can use button 3 & 4 to adjust the volume. With button 2 you can cycle through the presets. You can place the Tambaqui in standby mode by holding down button 1 until the device powers down.

**Button 1:** Mute/unmute, standby button (hold down until the device powers down)

**Button 2:** Go to next preset

**Button 3:** Volume down

**Button 4:** Volume up

## Updates

Click on the Check for updates button to check if there is new firmware available. When there is an update available an update button and information about the update will appear. Clicking on the Update button will direct you to the update page that will guide you through the update process.

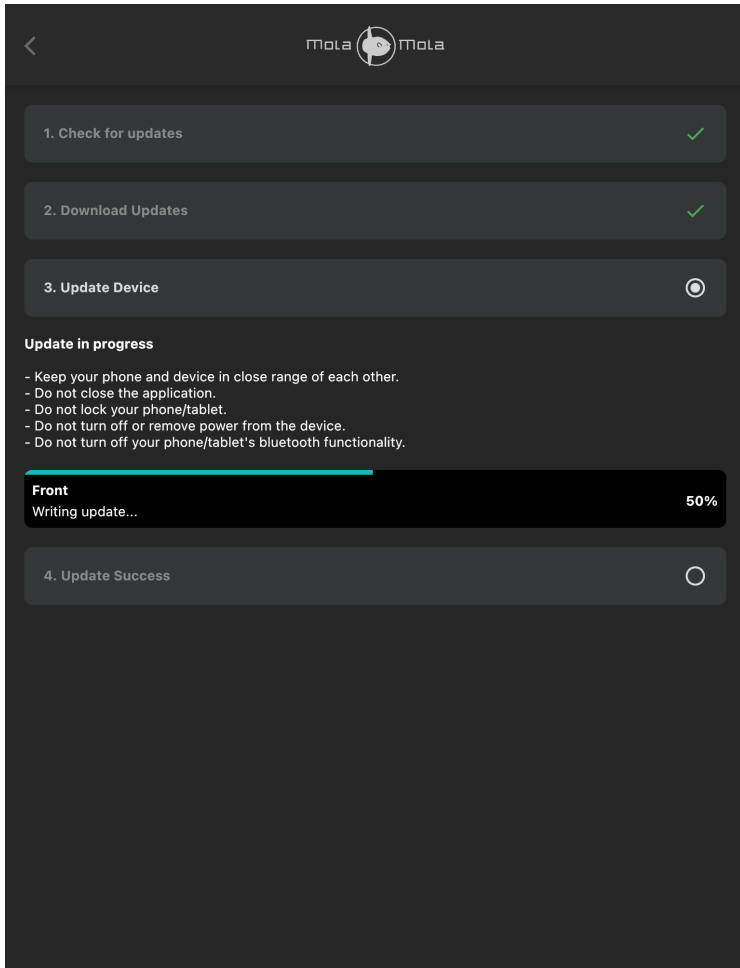

Figure 15: Update Page.

## Roon

The Tambaqui is a Roon Ready device. The device volume in Roon is linked to the volume control of the Tambaqui.

The Tambaqui supports convenience switching. If you press play in Roon and the selected preset in use does not have network as the source input, then Tambaqui will switch to the first preset with Roon that can be found. If there are no presets with Roon as input then preset 1 will be configured for Roon. After selecting a preset with Roon playback will start automatically.

### First time use

Before you can use the Tambaqui in Roon, it must be enabled first. To do this go to Settings and then select the Audio page. The Tambaqui will show up within a minute after powering up as a Roon Ready device (figure 15). Click on enable on give it a name of your choosing (figure 16).



Figure 16: The Tambaqui will show up on the Audio settings page in Roon



Figure 17: Fill in Zone Name

Select Tambaqui as the audio zone and then you can start playing your music.

### Network update

Updating of the Network module is done via the Tambaqui webpage. You can visit the Tambaqui webpage via Device Settings page in Roon. Click on the information symbol and then click on Configure Device (figure 17).



Figure 18: Click on Configure Device to go to the Tambaqui webpage

Or you can enter the IP address in your browser. The IP address of the Tambaqui is visible under Audio Device in Zone Settings or on the Audio settings page.

If there is a update available a update button is visible in the Tambaqui webpage.

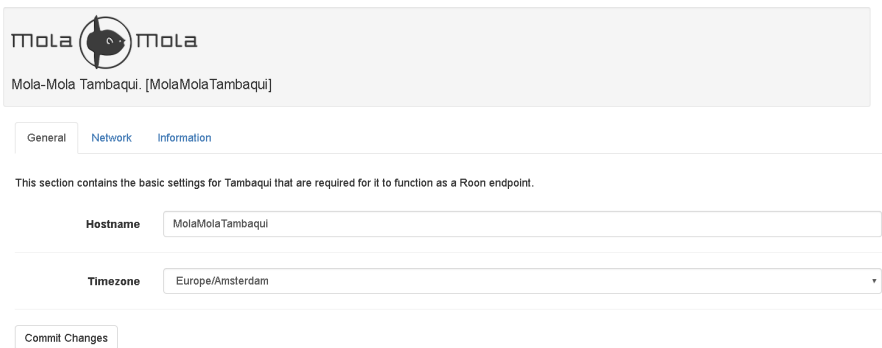

Figure 19: The Tambaqui webpage

## Drivers and updates

### *XMOS driver*

To play audio from a Windows computer via USB, you have to install a XMOS driver. The XMOS driver is available for download on the Mola Mola download page ([www.mola-mola.nl](http://www.mola-mola.nl)). MAC and Linux devices do not need this driver.

### *Firmware update*

The DIGIN module and the PWM DAC module contains firmware which can be updated. The update tool is available for download on the download page of Mola Mola ([www.mola-mola.nl](http://www.mola-mola.nl)). This update tool is available for Windows 7 and up and Mac OS 10.6 and up. How to update is described in the help file of the update tool. Before starting the update tool, make sure that the selected source is USB.

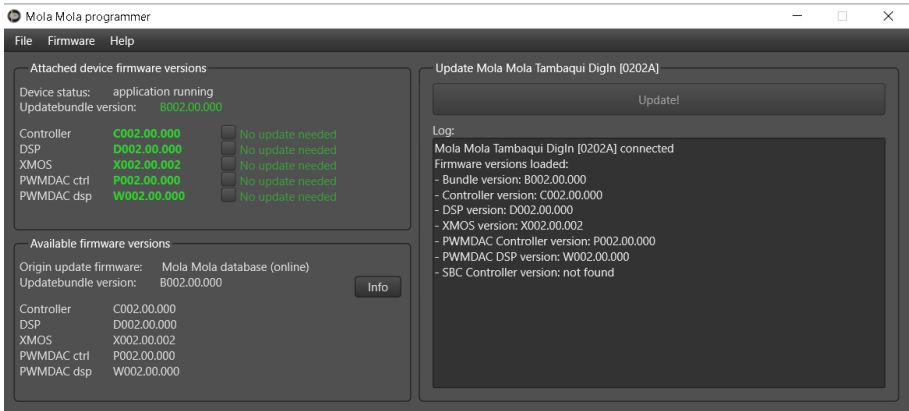

Figure 20: Firmware update tool.

## Troubleshooting

Most difficulties in audio systems are the result of incorrect connections, or improper control settings. If you encounter problems, isolate the area of the difficulty, check the control settings, determine the cause of the fault and make the necessary changes. If you are unable to get sound from your Tambaqui or its behaviour is not as expected, refer to the suggestions for the following conditions:

**No response when pushing buttons:** Verify the mains connection. Unplug the power cable from the Tambaqui and try to power another device with it. If this works, check the fuse. Lever out the little drawer underneath the mains input and replace the fuse that is hooked into the end of it. The second fuse that you see in a separate cavity of the fuse drawer is a spare. If the device still does not work, contact your local retailer. The device may need repair.

**The device responds (as witnessed by lights and clicking relays) but no sound:** Ensure that the source is connected to the selected input. Verify that the device is not in headphones mode when using preamplifiers or power amplifiers. Verify any such switches on your power amplifier too (and make sure it is on and wired correctly). When in complete doubt, restore the factory preset by holding down the two outer buttons for more than one second. Note though that this erases any programming you may have done.

**The volume control has no effect:** you have selected a preset that is programmed as fixed output (Direct mode). If you have not connected the Tambaqui to a volume controlled preamplifier or integrated amplifier, reprogram the routing to line before you continue using the product.

**The music drops out:** Upsampling of audio to high samplerates might trigger the DSD detection algorithm causing drop outs. To prevent this set Headroom adjustment to -6dB in Roon.

**Tambaqui is not shown in Roon:** The Roon Core and the Tambaqui must be connected to the same network.

## Audio performance data

Item	Symbol	Min	Typ	Max	Unit	Notes
Output level	Vout			18	dBu	(6.15 Vrms)
Output level headphones	Vout_hp			18	dBu	(6.15 Vrms)
Output Impedance	Zout			44	Ohm	
Output Impedance headphone connectors	Zout_hp			<0.5	Ohm	
Noise voltage headphone connectors	Vn		4.9 $\mu$		V	Unweighted at unity gain
Gain range		-80		0	dB	
Gain resolution				1	dB	
Bandwidth	Fc			80k	Hz	
Distortion (THD, IMD)	THD IMD			-140	dB	Not measurable using current test equipment, number is an estimate based on performance of the discrete gain block at maximum signal level
Integrated jitter				1 300	Ps fs	From 10Hz upwards From 1kHz upwards
Jitter rejection		80			dB	At 1Hz after 20 seconds of lock

Table 5: Audio Performance Data



## Technical data

Item	Value	Notes
Supply voltage	90-135 / 180 – 270 Volt AC/47-63Hz	Auto Switching
Power Consumption	40 Watt	
Dimensions	200mm*110mm*320mm	(W x H x D)
Weight	5.2 kg	
Fuse	T1,6A 250V 5x20mm ceramic	

*Table 6: Technical Data*

## Annex I: RC5 Codes

The IR device address is 16.

With front firmware 2.1 or higher the Tambaqui also responds to IR device address 18.

You can disable that the Tambaqui responds to IR device address 16 by enabling Ignore other remotes on the about page.

Command		Primary Code	Alternative Code
Mute		12	53
Volume Up		16	51
Volume Down		17	52
Presets 1...4		1...4	
Power on/off			50
Next preset			54
Previous preset			55

*Table 7: RC5 Codes*

10 consecutive repeats (no change in the T bit, i.e. holding the button depressed) of Mute or 1...6 powers the device down.

## Annex II: Standard Remote Control Unit

Button	Function	Notes
1	Mute, ON/OFF	Short press: Mute / Unmute / ON. Long press: OFF
2	Volume UP	Subsonic ON/ OFF when remote is programmed for Lupe (device address 21)
3	Volume DOWN	Mono ON/ OFF when remote is programmed for Lupe (device address 21)
4	Source UP	
5	Source DOWN	

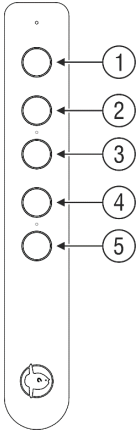

### Programming

The device address of the Standard Remote can be programmed to a default or a device specific device address. Hold button 1 and 5 simultaneously until the LED starts blinking. The number of consecutive blinks corresponds to the device address:

1. Default / Legacy / All devices (device address 16)
2. Makua (device address 17)
3. Kula (device address 19)
4. Tambaqui (device address 18)
5. Lupe (device address 21)

Press button 4 or 5 to scroll up or down through the device addresses. Press button 1 once the correct device has been chosen. The device has now been selected. Check the “ignore other remote” option in the app to have the device respond to the device specific device address only.

### Replacing the batteries

Place the remote control upside down on a hard surface. Be careful not to scratch it.

1. Unscrew both screws with a Phillips screwdriver.
2. Carefully remove the aluminium cover. Make sure the PCB stays in place.
3. Carefully remove the AAAA (LR8D425) batteries (1.5V Alkaline).
4. Place the new batteries. Mind the polarity!

**Replace only with the same type of batteries or equivalent.**

5. Reposition the aluminium cover and fasten the screws.

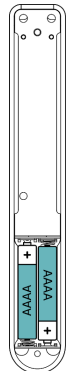

## Revision History

Revision	Description	Date
R0	Initial draft	16-10-2018
R1	Revised and expanded	03-12-2018
R2	Updated Mola Mola remote app Added new functionality New layout	11-03-2020
R3	Updated drawings	31-03-2020
R4	Updated caution for Direct mode Updated Screenshots	23-06-2020
R5	Updated Mola Mola remote app	01-10-2020
R6	Added Restore preset defaults Added Ignore other remotes Added warranty disclaimer	18-12-2020
R7	Added remote control info	30-09-2021
R8	Added LED brightness info Added Fuse specification	02-01-2023