

PSD 3100 HV

User manual

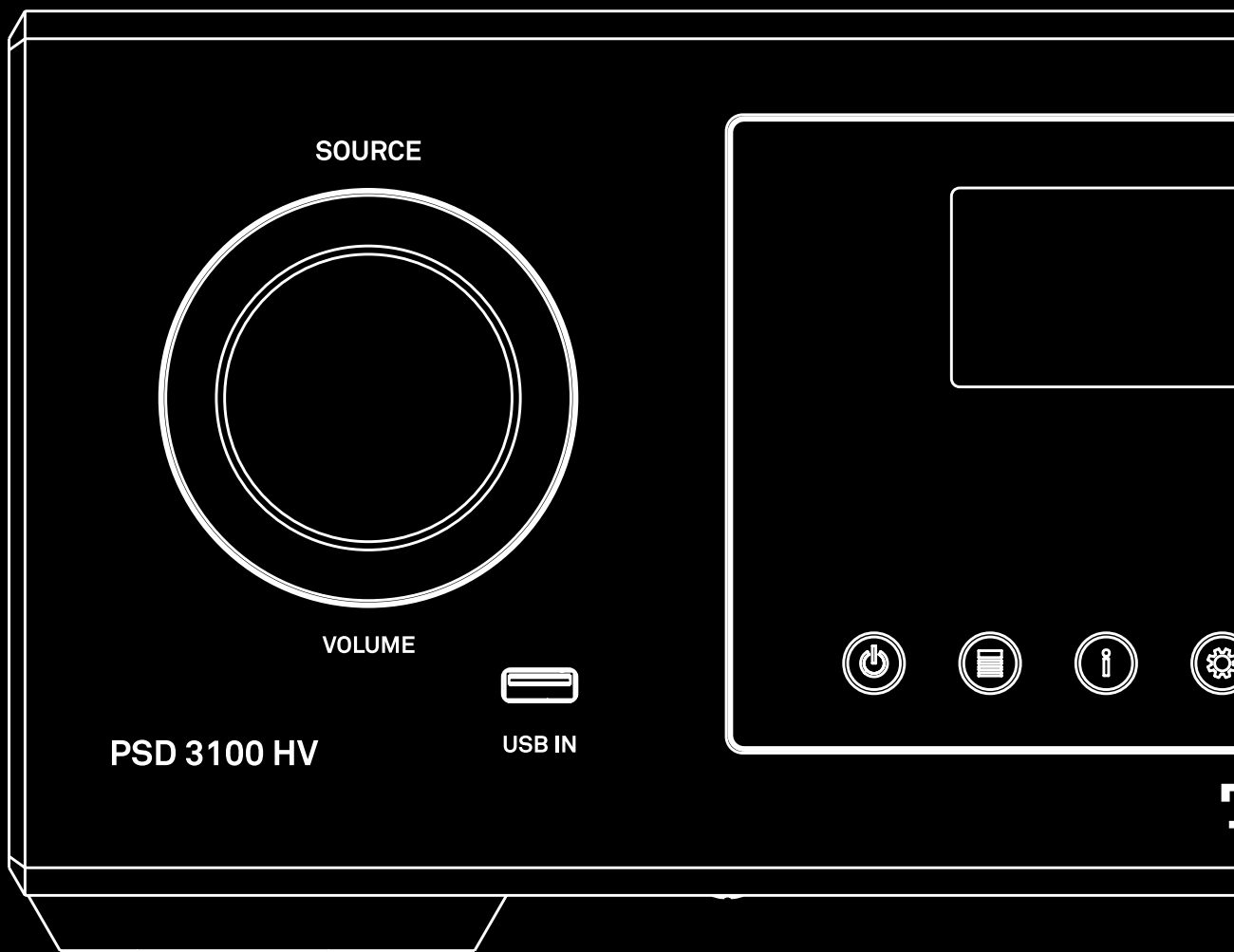

Welcome

We are delighted that you have decided to purchase a T+A product. Your new Multi-Source-Player is a Hi-Fi unit of the highest quality, designed and developed with a single aim as top priority: to satisfy the requirements of the audiophile music lover.

This unit is the embodiment of innovative thinking and solid quality, exploiting the finest materials and components available, and all these factors contribute to a machine which will satisfy you're most stringent demands and your most searching requirements for a period of many years.

Our production areas are supervised by highly qualified expert staff, and all final production units are checked comprehensively by a fully automated, computer-controlled system to ensure uniformly high quality. We guarantee that our products meet our own specifications to the full.

At all stages of production we avoid the use of substances which are environmentally unsound or po-

tentially hazardous to health, such as chlorine-based cleaning agents and CFCs.

We also aim to avoid the use of plastics in general, and PVC in particular, in the design of our products. Instead we rely upon metals and other non-hazardous materials; metal components are ideal for recycling, and also provide effective electrical screening.

Our robust all-metal cases exclude any possibility of external sources of interference affecting the quality of reproduction. From the opposite point of view our products' electro-magnetic radiation (electro-smog) is reduced to an absolute minimum by the outstandingly effective screening provided by the metal case.

We would like to take this opportunity to thank you for the faith you have shown in our company by purchasing this product, and wish you many hours of enjoyment and sheer listening pleasure with your PSD 3100 HV.

Content

Safety notes	10
Connections	12
ANALOG INPUTS / OUTPUTS	12
ANALOG OUT (VARIABLE)	12
ANALOG IN	12
HLINK	12
RADIO ANT	13
POWER SUPPLY	13
Installation and connection	14
Installation	14
Connection	14
LAN	14
WLAN	14
Connection of digital source devices	14
Connected to a PDT 3100 HV and/or A 3000 HV	14
Connecting the two power cords	14
Controls and functions	16
On- / Off switch	16
Volume control / Source selection	16
Navigation and control	16
Operating buttons	17
Headphones	17
USB front socket	17
Remote control receiver	17
Display	17
Remote control	18
On / Off Switch	18
Source selection	18
Muting	18
Volume control	18
Playback and menu operation	19
Function buttons	20
Range	20
Replacing the battery	20
Important information	21
T+A Music Navigator App (G3)	21
Download	21
Settings	22
Menu operation	22
System settings	23
D/A configuration	26
Tone configuration	27
Network configuration	28
General information	28

Menu operation	28
Connection via LAN (cable connection)	28
Connecting to WLAN (radio connection)	29
Source operation	31
Selecting a source	31
Browsing through lists	32
Playback	32
Display	33
Presets list	34
General information	34
Calling up the presets list	34
Adding a preset	34
Erasing an item from the Presets list	34
Play Presets	35
Sort Presets	35
Radio operation	36
General information	36
FM Radio	36
Display	36
Manual station search	37
Automatic station search	37
Mono / Stereo selection	37
Switching Radio text on and off	37
DAB Radio	38
Display	38
Automatic station search	38
Internet Radio	39
Display	39
Search function	39
Favorites	39
UPnP, Music services and USB	40
General information	40
Source selection	40
Display	40
Spotify Connect	41
Playback	41
Apple AirPlay	41
Playback	41
Amazon Music	42
Registration	42
Playback	42
Tidal Connect	42
Playback	42

Playback with Roon	43
General information	43
Playback	43
Bluetooth	44
General information	44
Source selection	44
Setting up audio transfer	44
Playback	44
D/A converter operation	45
General information	45
D/A Converter Operation	45
S/P-DIF (Digital IN 1 ... IN5)	45
HDMI	45
USB DAC	45
Troubleshooting	50
Notes on energy saving	52
General information	52
Automatic power down function	52
Legal Information	52
Allgemeine Informationen	52
Show licenses	52
Firmware update	53
General information	53
Update procedure	53
Connection and wiring	54
Specifications	56

Notes

User manual



Text passages marked with this symbol contain important information which must be observed if the machine is to operate safely and without problems.



This symbol marks text passages which provide supplementary notes and background information; they are intended to help the user understand how to get the best out of the machine.

Symbols and notes on the back of the PSD 3100 HV



This symbol marks alternating voltages (AC).
The AC voltage required for the device can be found on the printing at the mains input socket. Do not connect the device to other power supplies.



This symbol marks the protective earth connector (ground connection).
The unit is designed for operation at a protective earth conductor socket.



The device is designed to operate in altitudes up to 2000 m above sea level.



The device is designed to operate in a temperate climate.
The range of permissible operating temperatures is +10 ... +35°C.



The only permissible method of disposing of this product is to take it to your local collection centre for electrical waste.



All the components we use meet the German and European safety norms and standards which are currently valid. This product complies with the EU directives. The declaration of conformity can be downloaded from www.ta-hifi.com/DoC.



T+A declares conformity with the directives of the United Kingdom and the national laws derived from them by means of the symbol located on the device. The declaration of conformity can be viewed at www.ta-hifi.com/DoC if required.



Attention! Please refer to the important safety information in this manual.

License notices



The Spotify Software is subject to third party licenses found here:
www.spotify.com/connect/third-party-licenses.



Use of the Works with Apple AirPlay badge means that an accessory has been designed to work specifically with the technology identified in the badge and has been certified by the developer to meet Apple performance standards. Apple and AirPlay are trademarks of Apple Inc., registered in the U.S. and other countries and regions.



Qualcomm is a trademark of Qualcomm Incorporated, registered in the United States and other countries, used with permission. aptX is a trademark of Qualcomm Technologies International, Ltd., registered in the United States and other countries, used with permission.



The Bluetooth® word mark and logos are registered trademarks owned by Bluetooth SIG, Inc. and any use of such marks by T+A elektroakustik is under license. Other trademarks and trade names are those of their respective owners.



HD Radio Technology manufactured under license from iBiquity Digital Corporation. U.S. and Foreign Patents. HD Radio™ and the HD, HD Radio, and “Arc” logos are proprietary trademarks of iBiquity Digital Corp

This product contains software in form of object code that is partially based on free software under different licenses, especially the GNU General Public License.

The GPL license and further information about Licenses can be found on the internet under this link:

<https://www.ta-hifi.de/support/license-information-g3/>



Safety notes

For your own safety please consider it essential to read these operating instructions right through, and observe in particular the notes regarding setting up, operation and safety.

The operation instructions, the connection guidance and the safety notes are for your own good - please read them carefully and observe them at all times. The operating instructions are an integral part of this device. If you ever transfer the product to a new owner please be sure to pass them on to the purchaser to guard against incorrect operation and possible hazards.

The device is intended to be connected to mains outlets with protective earth connector. Please connect it only with the mains cable supplied to properly installed mains outlets with protective earth connector. The power supply required for this unit is printed on the mains supply socket. The unit must never be connected to a power supply which does not meet these specifications.

This device is connected to the power supply as long as the power cord is connected. Even if the device is switched off and the status indicators are dark, the device still carries mains voltage inside. To disconnect the device completely from mains power supply, the mains plugs must be withdrawn from the wall socket. Please make sure that the mains plugs are easily accessible. Even when the unit is in standby mode, it has a low power consumption. If the unit is not to be used for a long period disconnect it from the mains supply at the wall socket.



The device is designed to operate in a temperate climate and altitudes up to 2000 m above sea level. The range of permissible operating temperatures is +10 ... +35°C.



This device is designed exclusively for reproducing sound and/or pictures in the domestic environment. It is to be used in a dry indoor room which meets all the recommendations stated in these instructions.

Where the equipment is to be used for other purposes, especially in the medical field or any field in which safety is an issue, it is essential to establish the unit's suitability for this purpose with the manufacturer, and to obtain prior written approval for this usage.

If the unit gets very cold (e. g. when being transported), condensation may form inside it. Please do not switch it on until it has had plenty of time to warm up to room temperature, so that any condensation evaporates completely.

Before placing the unit on sensitive lacquer or wood surfaces please check the compatibility of the surface and the unit's feet on a non-visible point and if necessary use an underlay. We recommend a surface of stone, glass, metal or the like.

Please consider the weight of the device. Never place the device on an unstable surface; the machine could fall off, causing serious or even fatal injury. Many injuries, especially to children, can be avoided if the following simple safety precautions are observed:

- Use only such items of furniture which can safely bear the weight of the device.
- Ensure that the device does not project beyond the edges of the supporting furniture.
- Do not place the device on tall furniture (e.g. bookshelves) without securely anchoring both items, i.e. furniture and device.
- Explain to children the hazards involved in climbing on furniture to reach the device or its controls.

The unit should be set up in a well ventilated dry site, out of direct sunlight and away from radiators. The unit must not be located close to heat producing objects or devices, or anything which is heat sensitive or highly flammable.

The ventilation openings must not be covered or closed. If the system components are to be stacked then the device must be the top unit. Do not place any object on the top cover. The device is not designed to be operated on a soft surface (such as bedding, pillows, etc.).

When installing the unit on a shelf or in a cupboard it is essential to provide an adequate flow of cooling air, to ensure that the heat produced by the unit is dissipated effectively. Any heat build up will shorten the life of the unit and could be a source of danger. Be sure to leave free space of 10 cm around the unit for ventilation.

Liquid or particles must never be allowed to get inside the unit through the ventilation slots. Mains voltage is present inside the unit, and any electric shock could cause serious injury or death. Never exert undue force on mains connectors.

Protect the unit from drips and splashes of water; never place flower vases or fluid containers on the unit. Do not place naked flame sources, such as candle lights on the device.

Disconnect the mains plug at the wall socket before cleaning the case.

The surfaces of the case should be wiped clean with a soft, dry cloth only.

Never use solvent-based or abrasive cleaners!

Before switching the unit on again, check that there are no short-circuits at the connections, and that all cables are plugged in correctly.

If the device has been in storage, or has not been used for a protracted period (> two years), it is essential to have it checked by a specialist technician before re-use.



The terminals (marked with the ⚠-symbol) can carry high voltages.

Always avoid touching terminals and sockets and the conductors of cables connected to them. Unless ready-made cables are used, all cables connected to these terminals and sockets must always be deployed by a trained person.



In its original condition the unit meets all currently valid European regulations. It is approved for use as stipulated within the EC.

By attaching the CE symbol to the unit T+A declares its conformity the EC directives and the national laws based on those directives. The declaration of conformity can be downloaded from www.ta-hifi.com/DoC. The original, unaltered factory serial number must be present on the outside of the unit and must be clearly legible! The serial number is a constituent part of our conformity declaration and therefore of the approval for operation of the device. The serial numbers on the unit and in the original T+A documentation supplied with it (in particular the inspection and guarantee certificates), must not be removed or modified, and must correspond.

Infringing any of these conditions invalidates T+A conformity and approval, and the unit may not be operated within the EC. Improper use of the equipment makes the user liable to penalty under current EC and national laws.

Any modifications or repairs to the unit, or any other intervention by a workshop or other third party not authorised by T+A, invalidates the approval and operational permit for the equipment.

Only genuine T+A accessories may be connected to the unit, or such auxiliary devices which are themselves approved and fulfil all currently valid legal requirements.



The only permissible method of disposing of this product is to take it to your local collection centre for electrical waste.

Registration according to the EU directive
"Waste Electrical and Electronic Equipment"
WEEE-Reg.-No.: DE **72473830W**

The case should only be opened by a qualified specialist technician. Repairs and fuse replacements should be entrusted to an authorised T+A specialist workshop. With the exception of the connections and measures described in these instructions, no work of any kind may be carried out on the device by unqualified persons.

If the unit is damaged, or if you suspect that it is not functioning correctly, immediately disconnect the mains plug at the wall socket, and ask an authorised T+A specialist workshop to check it.

The unit may be damaged by excess voltage in the power supply, the mains circuit or in aerial systems, as may occur during thunderstorms (lightning strikes) or due to static discharges.

Special power supply units and excess voltage protectors such as the T+A 'Power Bar' mains distribution panel offer some degree of protection from damage to equipment due to the hazards described above.

However, if you require absolute security from damage due to excess voltage, the only solution is to disconnect the unit from the mains power supply and any aerial systems.

To avoid the risk of damage by overvoltages we recommend to disconnect all cables from this device and your HiFi system during thunderstorms.

All mains power supply and aerial systems to which the unit is connected must meet all applicable safety regulations and must be installed by an approved electrical installer.

The device is not designed for use by children. The device must not be operated unsupervised. Make sure that it is out of reach of children.

Batteries should not be exposed to excessive heat like sunshine, fire or the like.

Very loud continuous listening to program material via earphones, headphones and loudspeakers can lead to permanent loss of hearing. Prevent health risks and avoid permanent hearing at high volume.

If the device has to be stored, place it in its original packaging and store it in a dry, frost-free location. Storage temperature range 0...40 °C

Connections

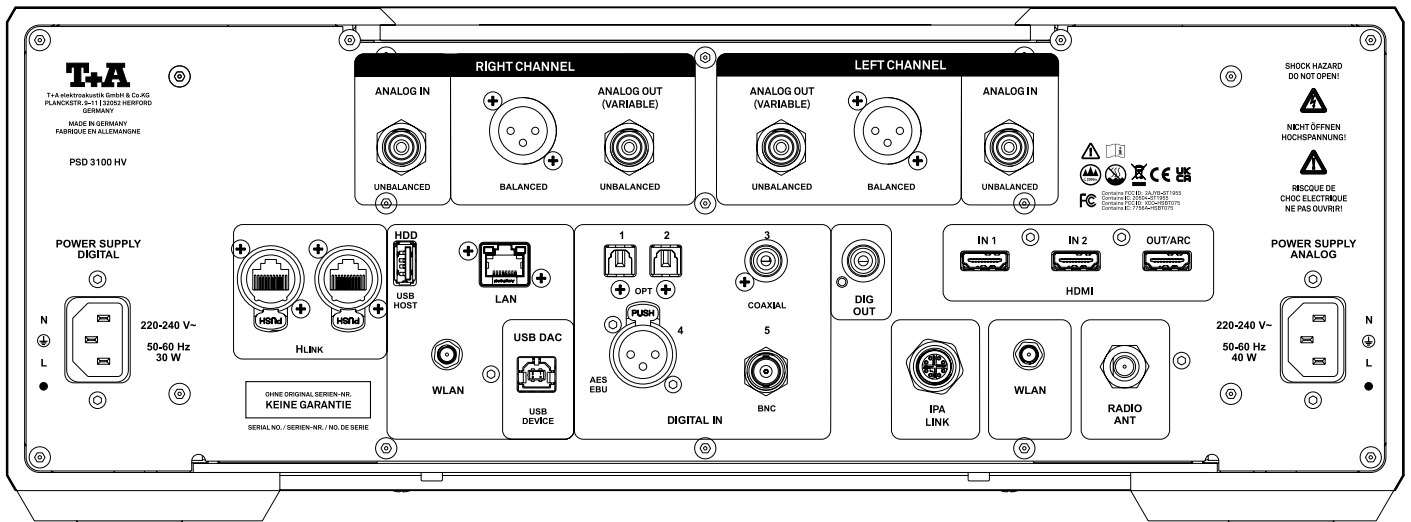

ANALOG INPUTS / OUTPUTS

ANALOG OUT (VARIABLE)

BALANCED	The balanced XLR output of the PSD 3100 HV provides analog stereo output signals with variable level. It is designed for operation with active loudspeakers or power amplifiers.
UNBALANCED	The unbalanced RCA output of the PSD 3100 HV provides analog stereo output signals with variable level. It is designed for operation with active loudspeakers or power amplifiers.

i If both types of connection are present on the connected amplifier, we recommend the symmetrical option to obtain the best possible sound quality.

ANALOG IN

UNBALANCED	Universal line input for connecting any stereo audio device with unbalanced RCA (Cinch) output.
-------------------	---

CONTROL

HLINK	Control output sockets for the T+A HLINK - System, e. g. for connecting an A 3000 HV. The sockets are equivalent.
--------------	---

USB STORAGE MEDIA

HDD USB HOST	Socket for a USB memory stick or external hard discs. The storage medium can be formatted with the FAT16, FAT32, extFAT, NTFS, ext2, ext3 or ext4 file system.
---------------------	--

i The USB storage medium can be powered directly via the USB port provided that its current drain is in accordance with the USB norm. Normalised 2.5" USB hard discs can be connected directly, i.e. without a separate mains PSU.

NETWORK CONNECTION

LAN	Socket for connection to a wired LAN (Ethernet) home network (Router).
WLAN	Input sockets for the two supplied WLAN antennas. For the best possible reception, both antennas should always be connected.

- i** *If no wired LAN connection is found, the PSD 3100 HV will automatically activate its WLAN module and it will try to get access to your WLAN network.*

USB AUDIO INPUT

USB DAC	Sockets for connecting a PC or MAC computer. At this input the PSD 3100 HV accepts digital PCM stereo signals with sampling rates in the range 44.1 to 768 kSps, and digital DSD stereo signals from DSD 64 to DSD 512. (DSD 256 and DSD512 only with a Windows PC)
---------	--

- i** *If you wish the PSD 3100 HV to convert audio files from a Windows PC connected to it, you must first install the appropriate drivers on the computer. No drivers are required if you are using a Linux or iOS. (Refer to chapter D/A converter operation / USB DAC)*

DIGITAL INPUTS / OUTPUT

DIGITAL IN 1 ... 5	Inputs for digital source devices with optical, co-axial (RCA / BNC) or AES-EBU digital outputs.
--------------------	--

- i** *At its digital inputs the PSD 3100 HV accepts digital stereo signals (S/P-DIF signals) with sampling rates from 32kHz up to 192 kHz.*

DIG OUT	Digital coaxial output for connecting an external recording device via coax cable.
---------	--

- i** *The digital output is not possible for all media, e. g. if the sampling frequency of the played source is higher than 192 kHz, or the DSD format is used.*

T+A DIGITAL-INTERFACE

IPA LINK	Special digital interface to connect the PDT 3100 HV. This connector is used to transmit digital signals in PCM and DSD format natively in the best possible quality.
----------	--

HDMI INPUTS

IN 1, IN 2, OUT/ARC	HDMI inputs (IN 1 and IN 2) for connecting a Blu-ray player or similar. At the „OUT“ socket, the picture signals of the two input sockets „IN 1“ and „IN 2“ are available for passing on to a television.
---------------------	---

RADIO ANTENNA

RADIO ANT	The PSD 3100 HV features a 75 Ohm aerial input FM ANT, which is suitable both for a normal domestic aerial and a cable connection. For first-class reception quality a high-performance, professionally installed aerial system is indispensable.
-----------	---

POWER SUPPLY

- i** *To avoid any coupling of unwanted noise signals from the digital power supply to the analogue power supply of the MP 3100 HV, the digital and analogue power supplies are located in separate shielded compartments on the left and right sides of the device. For best possible separation the power supplies have their own separate power supply sockets.*

Always connect both mains sockets to the mains supply when operating the PSD 3100 HV.

Installation and connection

Installation

Carefully unpack the device and store the original packaging carefully. The carton and packing material are specially designed for this device and will be a safe container during any later transports. Set up the device at a proper place. Please observe all notes on connection and set-up in the chapter Safety notes (pages 10 and 11).

Connection

To use the PSD 3100 HV with all its functions and sources, first you have to make some important connections and/or connect antennas. The necessary connections are described below:

 **Do not connect the PSD 3100 HV and the other components to the power supply until all the necessary connections have been established.**

LAN

For the connection to your network (router), connect the network cable to the LAN port.

 *When using the WLAN connection, this socket must remain free!*

WLAN

To connect the PSD 3100 HV to your network (router) via WLAN, connect both of the two supplied antennas to each of the WLAN sockets.

Connection of digital source devices

At the digital inputs of the PSD 3100 HV (Digital IN) you can connect devices with electrical coax, BNC, AES/EBU or optical fiber output.

 *The PSD 3100 HV accepts at all inputs digital stereo signals according to the S/P-DIF standard with sampling rates from 32 kHz to 192 kHz and DSD encoded stereo signals in DSD 64 format.*

Connected to a PDT 3100 HV and/or A 3000 HV

The PSD 3100 HV is designed for operation in conjunction with the PDT 3100 HV and/or A 3000 HV. For this purpose, the PSD 3100 HV is equipped with the HLINK system interface. If the PSD 3100 HV will be operated in conjunction with a PSD 3100 HV or/and an A 3000 HV, these interfaces must be connected. See also the wiring diagrams in the chapter Connection and cabling.

Connecting the two power cords

Connect both mains sockets to the mains supply when operating the PSD 3100 HV.

PDT 3100 HV

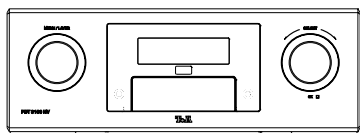

HLink

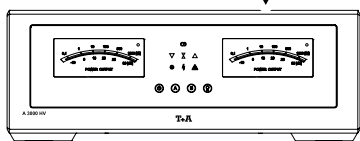

A 3000 HV

HLink

TV.

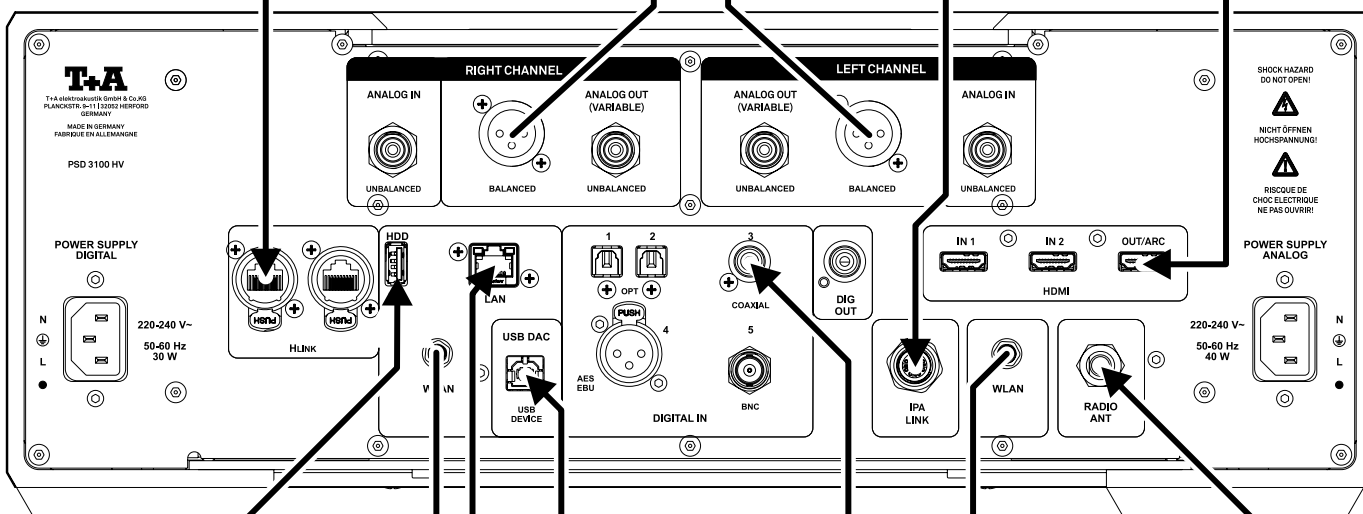

USB storage

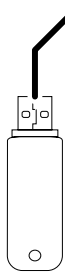

Computer
USB DAC

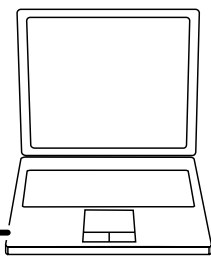

Network storage

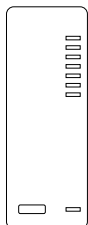

Internet access LAN or WLAN

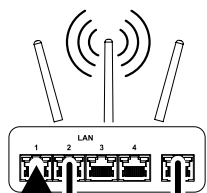

Digital source device



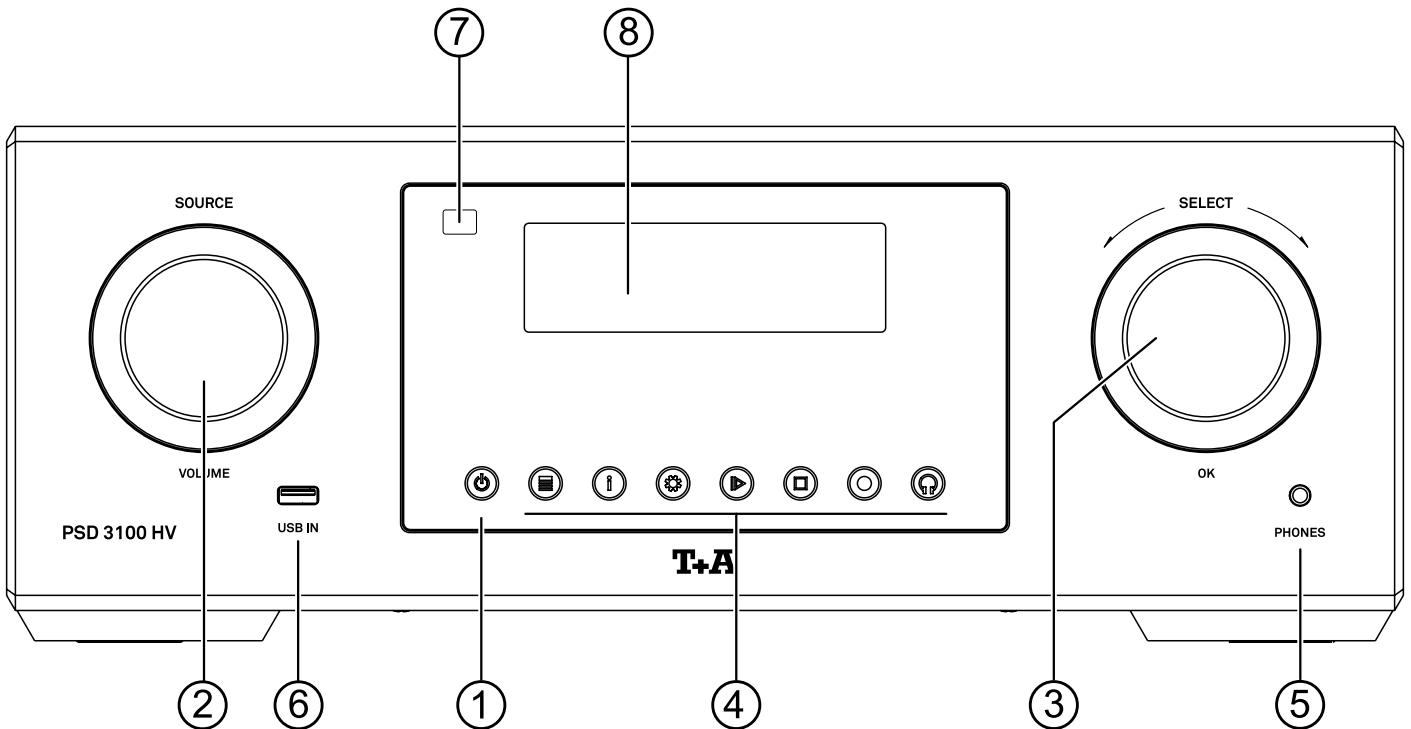

Controls and functions



① On- / Off switch



Touching the  button briefly switches the device on and off.

 The  button remains dimly lit even in stand-by mode, to indicate that the PSD 3100 HV is ready for use.

② Volume control / Source selection

SOURCE /
VOLUME

This rotary knob is used to set your preferred volume in accurate 1 dB increments. The value currently set is displayed on the screen. To select the desired listening source, briefly press the knob before rotating it; your chosen source then appears on the screen. After a short delay the machine switches to the appropriate source.

 The main function of this knob can be changed if necessary. In this case, the button must be pressed briefly before the volume can be changed (see chapter 'Basic settings of the PSD 3100 HV').

A long press on this knob switches to balance adjustment: turning the knob to left or right then alters the balance in the corresponding direction. Press the knob again long to conclude the adjustment and save the setting.

③ Navigation and control

SELECT

Rotating this control selects a track for playback; the selected track then appears on the screen. As soon as the desired track number lights up, the track can be started by pressing the incremental control.

 In addition to selecting tracks, the SELECT-knob also has other purposes such as menu and list control functions. For further details see the chapter entitled 'SETTINGS'.

④ Operating buttons



Calls up the Favourites list



Brief touch: Switches the display view from list navigation to the current played music track. / switches the CD- / Radio - Text on and off.
Long touch: Switches between different screen displays



Opens the 'System Configuration' menu
(for further details see the chapter entitled *SETTINGS*)



Starts playback
Halts current playback (pause)
Resumes playback after a pause



Ends playback
During menu operation: A brief press takes you back (higher) by one menu level or aborts the current input process; the change is then abandoned.



A brief press switches the outputs (XLR and RCA) on and off (MUTING function).

i *The outputs can also be switched automatically alternating with the headphone jack. In automatic mode, the button is not visible when the headphones are connected. See chapter ,SETTINGS':*



This button is used to switch the headphone output on and off.

i *The headphone jack can also be switched automatically alternating with the preamplifier outputs. In this case, the button is only visible when headphones are connected. See chapter *SETTINGS*.*

⑤ Headphones

PHONES

Balanced Pentaconn jack socket 4.4 mm for stereo headphones with an impedance of at least 16 Ohms .
A high quality adapter is available in the T+A accessories range for connecting headphones with a standard 6.3 mm jack socket.

⑥ USB front socket

USB IN

Socket for a USB memory stick or an external hard disc.
The storage medium can be formatted with the FAT16, FAT32, NTFS, ext2, ext3 or ext4 file system.
The USB storage medium can be powered via the USB socket provided that its current drain meets the USB norm (< 500 mA). Normalised 2.5" USB hard discs can be connected directly to this socket, i.e. they require no mains PSU.

⑦ Remote control receiver

When using the remote control system please point the F3100 handset in the direction of the receiver.

⑧ Display

The graphic screen of the PSD 3100 HV displays all information regarding the status of the machine, the music track currently being played and the radio station currently tuned. The display is context-sensitive and varies according to the capabilities and facilities of the service or medium to which you are currently listening.

Remote control

On / Off Switch



A brief press switches the PSD 3100 HV on or off.

Source selection

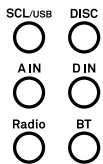

SCL/USB	DISC	Selects the SCL function (e.g. access to music servers, streaming services or similar) or the USB DAC function (playback from a connected computer), or selects the USB Media function (connected USB memory media) of the streaming client. Press this button repeatedly until the desired source appears on the screen.
A IN	D IN	
Radio	BT	
DISC		With the PDT 3100 HV connected, this button selects the IPA-Link input as source.
A IN		A brief press on this button selects the analogue input.
D IN		A brief press on this button selects the digital input you wish to use. Press the button repeatedly until the desired input is displayed on the screen.
Radio		Selects FM, DAB, Internet radio or Podcasts as source. Press this button repeatedly until the desired source appears on the screen.
BT		Selects Bluetooth as source.



NOTE

Not required sources can be deactivated in the system settings for an even more comfortable source selection.

Muting



Switches the preamplifier output of the PSD 3100 HV on and off.



Switches the speaker output of a connected HV-series power amplifier on and off.

Volume control

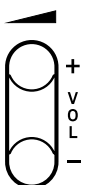

Increase / decrease volume

The volume can be increased / decreased in steps by tipping one of the volume buttons. The current volume level is displayed on the display screen. If one of the buttons is kept pressed for approx.. 1 seconds the volume increases / decreases continuously until the button is released.

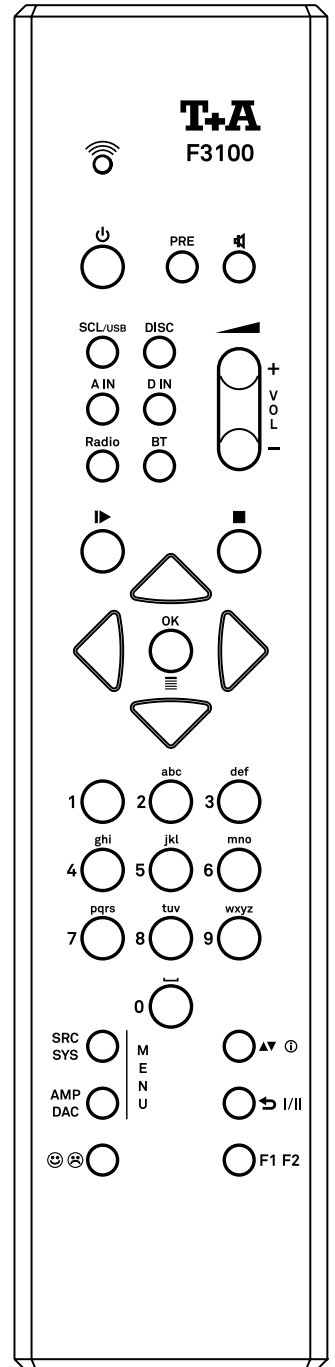

Playback and menu operation

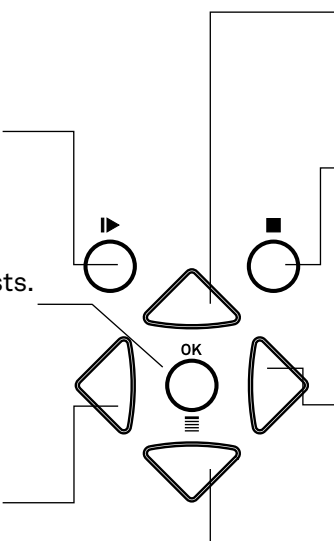
- 
- Starts playback (Play function)
 - During playback: halts (Pause) or resumes playback
 - Confirmation button in lists.
 - A long press displays the Favourites list created on the PSD 3100 HV
 - Returns to list navigation during playback.
 - Press and hold to search backwards.
 - Returns to the previous point / change button
 - Selects the previous item within a list.
 - Selects the next track/station during playback.
 - Stops playback.
 - During menu operation: A brief press takes you back (higher) by one menu level or aborts the current input process; the change is then abandoned.
 - Enter the next list level.
 - Starts playback.
 - Press and hold to search forward.
 - Selects the next item within a list.
 - Selects the previous track / station during playback.



SRC SYS
 Brief press: Opens the Source menu (not available for all sources)
 Long press: Opens the "System configuration menu" (see the chapter entitled 'Basic settings of the PSD 3100 HV')



AMP DAC
 Brief press: Opens the tone settings menu in enlarged view.
 Long press: Opens the tone settings in list view. (see the chapter entitled "Tone configuration")

Alpha-numeric entry

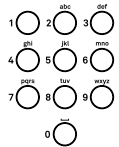



To enter a source name, user data or network parameters, first activate the relevant input field with the **OK** button.

If necessary, existing entries can be deleted by pressing the  button repeatedly.

Enter the desired character string using the alphanumeric keypad on the remote control.

Press the **OK** button to confirm the entry.

Use the   button for toggling between numbers, capitals and lower-case letters. The bottom line of the screen shows which input mode is currently selected.

123

1234567890

abc

abcdefghijklmnopqrstuvwxyz -*/^={ } () [] < > . , ? ! : ; \ ' _ @ \$ % & # ~ 0 1 2 3 4 5 6 7 8 9

ABC

ABCDEFGHIJKLMNOPQRSTUVWXYZ -*/^={ } () [] < > . , ? ! : ; \ ' _ @ \$ % & # ~ 0 1 2 3 4 5 6 7 8 9



The 0 button contains the special characters 0 + - * / ^ = { } () [] < > and the button 1 can be used to select the characters ,, , ? ! : ; 1 \ , , _ @ \$ % & # ~

Function buttons



A brief press
Adds a favorite to the Presets list
In the system configuration menu: Activates a source

A long press
Removes a favorite from the Presets list.
In the system configuration menu: Deactivates a source



A brief press
Switches between capitals and lower case, and numeric / letters, when entering data.

A long press
Cycles through the various screen displays.
Detailed display with / without CD text / Radiotext (if present) and large display with / without CD text / Radiotext (if present).



A brief press
When necessary, repeated presses of the button cycle through the various playback modes (repeat track, repeat all, etc.).

A long press
Switches the MixMode (Shuffle) on or off.
Only FM Radio: Switches between Stereo and Mono reception



A brief press
Opens the D/A mode selection menu.

Range

When operating by remote control, please hold the F3100 in the direction of the remote control receiver.
The range of the remote control is approx. 4..5 m.
The line of sight between F3100 and the remote control receiver must not be interrupted by obstacles.
The direct incidence of interfering light (e.g. from fluorescent and energy-saving lamps) into the receiver should be avoided at all times, as otherwise the range of the remote control can be considerably reduced.

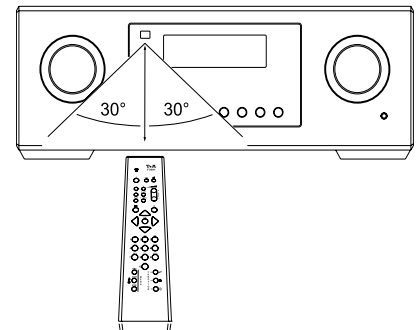

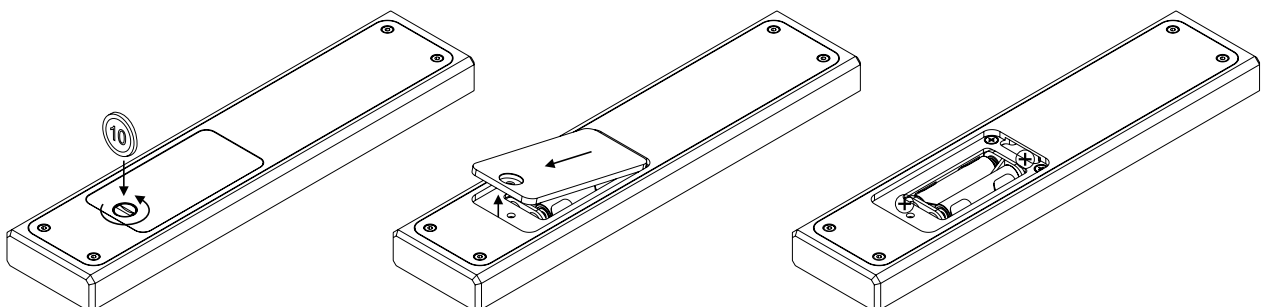

Replacing the battery

Remove the screw marked in the figure below, to open the battery compartment, then withdraw the cover. Insert two new cells of the LR 03 (MICRO) type, taking care to maintain correct polarity as shown. Please note that you must always replace all the cells.



Important information

-  • **If the battery is replaced improperly, there is danger of explosion. Always replace batteries by batteries of the same or an equivalent type.**
-  • Even if the device is not used for a long time, the batteries should be replaced every two years at the latest.
- **Keep new and used batteries well away from children.**
- **If you cannot close the battery compartment securely, cease using the product, and keep it away from children.**
- **Batteries should not be exposed to excessive heat like sunshine, fire or the like.**
- **Very low air pressure may result in explosion of the battery, or leakage of flammable liquids or gases.**
- **Protect the remote control from humidity, coldness, heat and dust.**
- *Exhausted batteries must never be thrown into the household waste! They should be returned to the battery vendor (specialist dealer) or your local toxic waste collection point, so that they can be recycled or disposed in a proper way. Most local authorities provide collection centres for such waste, and some provide pick-up vehicles for old batteries.*

T+A Music Navigator App (G3)

Download

Two Apps are available for controlling the sound system using the Apple iOS and Android operating systems. Please download the appropriate version from the Appstore and install it on your tablet PC or smartphone.

You will find the App under the name “TA MUSIC NAVIGATOR G3” in the Appstore. Alternatively you can scan the QR code printed below.

Android Version





Apple iOS Version



Settings





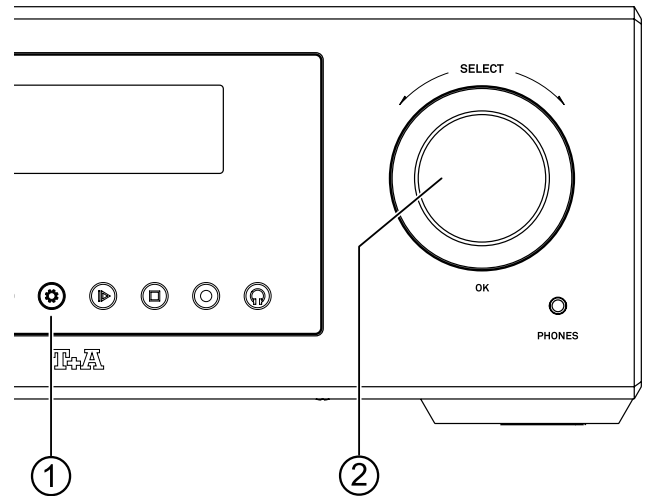

Menu operation

Operation on the device

- To call up the **system settings** menu, press the  button ① on the front of the PSD 3100 HV.
- Select an item in the menu with the SELECT knob ②.
- To change a selected menu item, confirm by pressing the SELECT knob and then change it by turning the knob.
- To confirm the setting, press the knob again after the change.
- To cancel a change, you can always press the SELECT button for a long time or briefly press the  button.
- By pressing the SELECT knob for a long time, you can return to the previous menu level.
- To exit the menu, press the  button.



Operation by remote control

- A long press on the **SRC / SYS** button on the remote control opens the **system settings** menu.
- Use the   buttons to select an item in the menu.
- To change a selected menu item, first press the **OK** button and then use the   buttons to alter the setting.
- To confirm the setting, press the **OK** button again after changing it.
- To cancel a change, you can always abort by a brief press on the  button.
- Press and hold the  button to return to the previous menu level.

To exit the menu, press the **SRC / SYS** button.

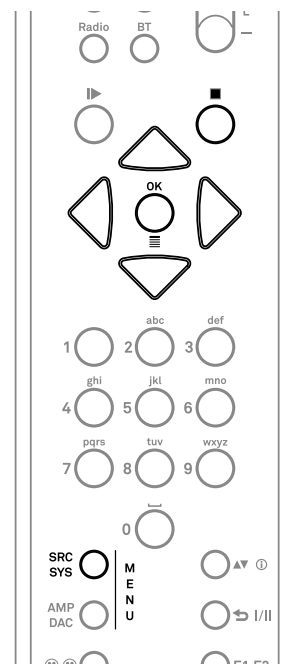

System settings

D/A configuration This item opens the D/A Converter Settings menu. For details, refer to chapter *D/A configuration* (Page 26).

Tone configuration This item opens the menu for tone settings. For details, refer to chapter *Tone configuration* (Page 27).

Source configuration Under this menu item you can disable not used sources, and assign a plain text name to each source which is in use; this name then appears in the screen displays.

You can also assign a plain text name for the display to the external sources (digital inputs and Bluetooth).

When this menu item is called up with the **OK** button, a list of all sources of the PSD 3100 HV appears.

Each source is followed by the displayed plain text name or the note *Enabled* for an active source or *Disabled* if the source is deactivated.

Disable not required sources

A long press on the green 😊 😞 button deactivates the selected source. To activate a disabled source, press the green 😊 😞 button briefly.

Change the source name

To change the plain text name, first select the corresponding source and press the button.

Delete the previous name by repeatedly pressing the ◀ button.

Now use the alpha-numeric keypad of the F3100 to change the name as required, then confirm your choice with **OK**; this saves the settings for that source.

To switch between numeric and alphanumeric input as well as upper/lower case, press the ▲▼ ⓘ button.

If you should wish to restore the factory default source name, erase the whole name before saving the empty field with the ◀ button: this action resets the display to the standard source names.

ⓘ *The only available method of entering the name is to use the alpha-numeric keypad on the remote control handset.*

Passthrough If you wish to connect a device with its own volume control (e.g. TV set), this menu point can be used to disable the volume control of the PSD 3100 HV for the Analog IN 1 or IN 2 input (pass-through mode).

ⓘ *You should only select this setting if a device with its own volume control is connected to the unit. Ensure that the volume of the source device is turned down to zero before connecting it to the PSD 3100 HV, otherwise the speakers connected to it may be damaged through overloading.*

Headphone mode The PSD 3100 HV detects headphones automatically.
In the “Automatic” setting the pre-amplifier output is automatically switched off when headphones are connected. If you wish to be able to control these outputs separately, select the “Manual” setting.

Left rotary knob	Under this menu item you can define the main function of the left rotary knob. The set main function can be operated without pressing the knob first. For the second function, the knob must be pressed briefly first. Select „Volume/Source“ when volume control should be the main function or select „Source/Volume“ if source selection is the preferred main function.
Pre volume after power on	Here you can select whether the PSD 3100 HV is switched on with the volume selected before switching off, a maximum permissible volume or always the same volume. Unchanged If this setting is selected, the device is switched on with the volume before switching off. Limited With this setting, a maximum permissible volume can be set under the menu item „Value“. permissible volume after switching on can be defined under the menu item „Value“. Fixed value If this option is activated, the PSD 3100 HV always switches on with the volume value set under the menu item „Value“
Display Brightness (Screen Brightness)	At this point you can adjust the brightness of the integral screen to suit your personal preference for normal use.
Display mode	This menu item offers the choice between three different display operation modes: <ul style="list-style-type: none"> • Always on • Temporary • Always off Selecting ‚Temporary‘ will switch the display is on for a short while each time the PSD 3100 HV is being operated. Shortly after operation the display will be switched off again automatically.
Language	In this menu item you define the language to be used for the displays on the screen of the front panel of the PSD 3100 HV. The language used for data transferred to the machine, e.g. from an Internet radio station, is determined by the supplying device or the radio station; you cannot define the language on the PSD 3100 HV.
Device name	This menu point can be used to assign an individual name to the PSD 3100 HV. In a home network the device then appears under this name.
<p> <i>If the device is integrated into an Apple Home environment, the device name can only be changed via the Apple Home app.</i></p>	

Energy Saver	<p>The PSD 3100 HV features two stand-by modes: ECO Standby with reduced stand-by current drain, and Comfort Standby with additional functions, but slightly higher current drain. You can select your preferred stand-by mode in this menu point:</p> <p>On (ECO standby):</p> <p>Active functions in ECO standby mode:</p> <ul style="list-style-type: none">• Power-on at the device itself.• Automatic power-down after ninety minutes without signal (only possible with certain sources). <p>Off (Comfort standby):</p> <p>The following expanded functions are available:</p> <ul style="list-style-type: none">• Unit can be switched on using the app.• The automatic power-down function is disabled in Comfort standby mode.• The picture and sound signals at the HDMI 1 and 2 sources are passed on to the connected TV even if the device is in standby mode.
---------------------	--

Network	<p>All network settings can be carried out at this menu point. For a detailed description on setting up a LAN or WLAN connection please also refer to the section entitled Network configuration on page 28.</p>
----------------	--

Device Info	<p>At this menu point you will find information on the status of the installed software and the factory reset.</p>
--------------------	--

D/A configuration

PCM D/A mode

The PSD 3100 HV can exploit four different filter types offering different tonal characters:

- **OVS long FIR**

is a classic FIR filter with an extremely linear frequency response.

- **OVS short FIR**

is a FIR filter with improved peak handling.

- **OVS Bezier / FIR**

is a Bezier interpolator combined with a IIR filter. This process produces a result very similar to an analogue system.

- **OVS Bezier**

is a pure Bezier interpolator – offering perfect “timing” and dynamics.

For special applications, e.g. if the source device is doing the upsampling (such as a PC with Signalyst® HQ player), the upsampling in the PSD 3100 HV can be deactivated. The following two NOS modes are available for this purpose.

- **NOS 1**

With this setting the upsampling of the PSD 3100 HV is deactivated and the analog output filter is automatically set to 60 kHz for sampling rates of 44.1 and 48 kHz. For higher sampling rates, the setting you selected under the *Bandwidth* menu item is used.

- **NOS 2**

If you select this setting, upsampling of the PSD 3100 HV is deactivated. The analogue output filter always has the value selected under the menu item *Bandwidth*.

DSD D/A mode

The PSD 3100 HV offers two different converter modes for DSD playback.

- **DSD 1**

This is a long filter with very low noise and very good noise rejection.

- **DSD 2**

In DSD 2 mode, two shorter filters operate in parallel. This filter produces even lower distortion than DSD 1 mode.

Output

With particular instruments or voices the human ear is certainly capable of detecting whether absolute phase is correct or not. However, absolute phase is not always correctly recorded.

In this menu item the phase of the signal can be changed from normal to inverse phase and back.

Bandwidth

In this menu item, the bandwidth of the analogue output filter can be switched between 60 kHz (normal mode) or 120 kHz (‘WIDE’ mode).

The ‘WIDE’ setting allows a more spacious music reproduction.

Tone configuration

Balance	This menu point is used to alter the balance in level between the left and right channels, e.g. to compensate for non-symmetrical loudspeaker positioning. The balance can be adjusted in increments of 1 dB; the screen always displays the current value.
----------------	---

Loudness	The PSD 3100 HV is equipped with a volume-dependent tone control (LOUDNESS) circuit, which compensates for the frequency-dependent sensitivity of the human ear at very low volume levels, due to the characteristics of aural physiology. This menu point is used to switch the loudness circuit on and off.
-----------------	--

Loudness level	This menu point is used to adjust Loudness to suit the loudspeakers and the listening room.
-----------------------	---

Tone control	This menu point can be used to disable (by-pass) the PSD 3100 HV's tone controls. To switch off the tone controls, select the "OFF" setting. When the tone controls are switched off, any adjustments you make to the following menu points "BASS" and "TREBLE" have no effect.
---------------------	---

Treble	Under this menu item you can disable not used sources, and assign a plain text name to each source which is in use; this name then appears in the screen displays.
---------------	--

Bass	If you wish to connect a device with its own volume control (e.g. TV set), this menu point can be used to disable the volume control of the PSD 3100 HV for the Analog IN 1 input (pass-through mode).
-------------	--

Network configuration

General information

All network settings are carried out in the system settings under the menu item Network.
If the PSD 3100 HV is not connected to a wired network via its LAN port, the WLAN module is activated and the the Network menu displays the menu items for setting up the WLAN connection.

i If you want to connect the PSD 3100 HV to the home network via WLAN, the LAN port must remain free.

Menu operation

- Open the system settings menu by pressing the **SRC / SYS**-button on the remote control.
- Select the Network menu item with the ∇/\triangle buttons and confirm with the OK - button.
- In the network menu, select the network parameter to be changed with the ∇/\triangle buttons and activate the entry with the OK - button.
- Now you can change the setting depending on the type with the following buttons:
 - \triangle/∇ buttons at simple selection (ON/OFF)
 - ∇/\triangle buttons at IP addresses and alphanumeric input of text.
- After the setting has been made or the address has been entered completely, confirm the entry with the OK - button.

i The network parameters can only be set using the remote control.

Connection via LAN (cable connection)

- Connect the PSD 3100 HV to an operational network (router) or power line modem via the rear LAN port.
- Switch on the PSD 3100 HV.
- Usually, an IP address is automatically assigned to the PSD 3100 HV by your router (via DHCP) and the PSD 3100 HV is ready for operation after the start-up process of the streaming module.
- If this is not the case, open the network menu (Network) and set the network parameters listed below according to your network settings.

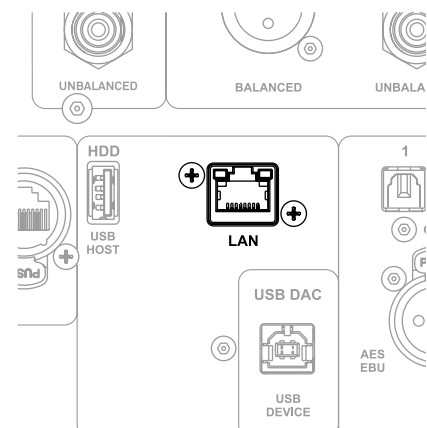

Menu item	Setting / Explanation
MAC	The MAC address is a hardware address which uniquely identifies your machine. The address displayed is determined by the manufacturer, and cannot be altered
Connction state	Shows the connection state: WLAN, LAN or not connected

DHCP	<p>on</p> <p>If your network includes a DHCP server, please select the ON setting at this point. In this mode an IP address is automatically assigned to the PSD 3100 HV by the router. The screen shows only the MAC address and the message DHCP state ON. In this case the address input fields shown in the illustration do not appear in the menu.</p> <p>off</p> <p>If your network does not include a DHCP server, please select the OFF setting. In this mode you must configure the following network settings manually. Please ask your network administrator for the addresses to be entered for your network.</p>
IP	IP Adress of the PSD 3100 HV
Subnet mask	Network mask
Gateway	IP Adress for the router
DNS	Name / IP of the name server (optional)
Store and exit?	Stores the network parameters, and restarts the PSD 3100 HV with the new settings
Discard and exit?	Closes the menu: data already entered is discarded

Connecting to WLAN (radio connection)

- Connect both of the supplied WLAN antennas to the WLAN sockets on the back of the PSD 3100 HV. Depending on your reception and set-up situation, the antenna can be mounted directly on the socket on the back or together with the magnetic base supplied.

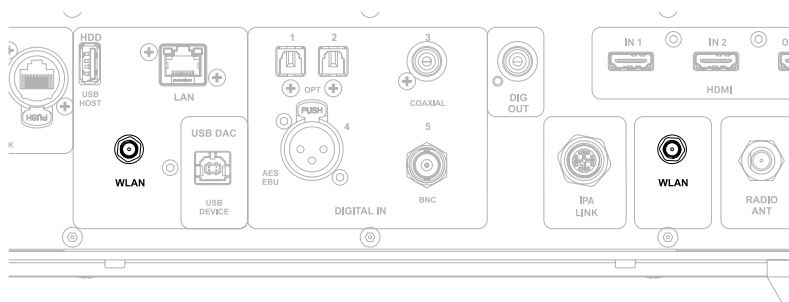

- For setting up the WLAN connection, open the menu for system settings and then the menu item Network.

Menu item	Setting / Explanation
MAC	The MAC address is a hardware address which uniquely identifies your machine. The address displayed is determined by the manufacturer, and cannot be altered.
Connction state	Shows the connection state: WLAN, LAN or not connected.
WPS autoconnect	Activates the WPS function to connect the PSD 3100 HV to the WLAN via WPS. See chapter <i>Setup via the WPS function</i> .
Scan for WLAN	Starts the scan for WLAN networks that are within reception range.

 All other menu items are the same as for the connection via LAN. See above for more information.

Configuration using the WPS function

- First activate the WPS-function of the Router or Repeater to which you wish the PSD 3100 HV to be connected. For details please refer the manual of the device in question.
- Start the WPS-Autoconnect function of the PSD 3100 HV within 2 minutes.
- Use the ▽△ buttons to select the menu point “WPS-Autoconnect”, then confirm your choice with OK - the button.
- After the connection is established, the line Status shows the connected WLAN network.
- Finally select the “Store and exit?” menu point and press the OK - button to accept the settings.

Manual setup of the WLAN connection

- First select the Scan for WLAN menu item and confirm it with the OK - button.
- A list of the WLANs found appears.
- Use the ▽△ buttons to select the WLAN to which you wish the PSD 3100 HV to be connected, and confirm your choice with the OK - button.
- Enter the network password (passphrase) and confirm your entry with OK.
- Confirm and store the settings by selecting the item *Store and exit?* and pressing OK.
- Finally, select the menu item *Store and exit?* again and confirm the settings with the OK - button again.

Setting up the WLAN connection via the T+A app (TA Music Navigator)

For an easy setup of the network connection, the PSD 3100 HV has an access point function. This is automatically activated whenever the device is neither connected to the network via cable nor a WLAN network has been configured. This state can be restored at any time by resetting the PSD 3100 HV to the factory default settings (see p. 25 item Device info).

Proceed as follows to set up the device:

using Android

- Connect the smartphone or tablet PC on which the T+A TA Music Navigator app is installed to the WLAN access point.
- The name of the network (SSID) starts with T+A AP 3Gen_.... a password is not required.
- Start the app.
- The app detects the access point and automatically starts the setup wizard.
- To set up the WLAN, you must go through the individual steps of the app's setup wizard.
- Exit the app and then connect the smartphone or tablet to the previously set up WLAN.
- After restarting the app, the PSD 3100 HV will be automatically searched for.
- Once the PSD 3100 HV has been detected, it can be selected for playback.

using iOS (Apple)

- The PSD 3100 HV supports the Wireless Accessory Configuration,(WAC).
- Power on the PSD 3100 HV.
- Open the menu for the settings/WLAN on your iOS mobile device.
- As soon as the device is started, you will find under the item Set up new Airplay speaker an entry that starts with T+A AP 3Gen_.... .
- After selecting this entry, you can select the network to which your PSD 3100 HV can be connected.
- After confirming the selection, the configuration data of the network is automatically transferred to the device and the PSD 3100 HV connects to the selected network.

Source operation

Selecting a source

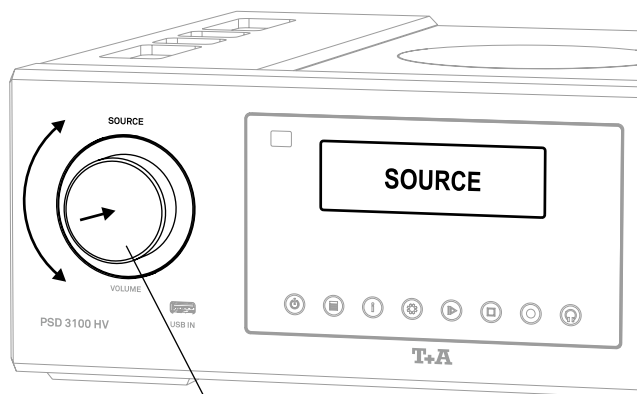

Source selection rotary knob

To select the desired audio source, first briefly press the rotary knob to enter the source selection. Now select the source by turning the left rotary knob; the selected source then appears on the screen. After a short delay, the device switches to the corresponding source.

Source selection buttons

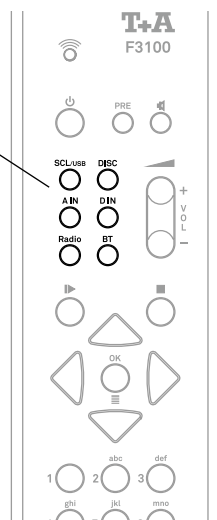

A brief press on these buttons selects the desired source. To simplify the source selection, the sources are grouped by category on one button each. Press the appropriate button repeatedly, if necessary, until the desired source is shown in the PSD 3100 HV display.

i The main function of the left knob can be configured according to your preferences. (See chapter **System settings**).

Either the volume can be adjusted directly and for the second function of the knob, the source selection, the knob must be pressed briefly first, or vice versa, which means that for the volume adjustment the knob must be pressed briefly first.

For a faster and more convenient source selection, not required sources can be deactivated in the system settings. See chapter **Settings/System settings**.

Browsing through lists

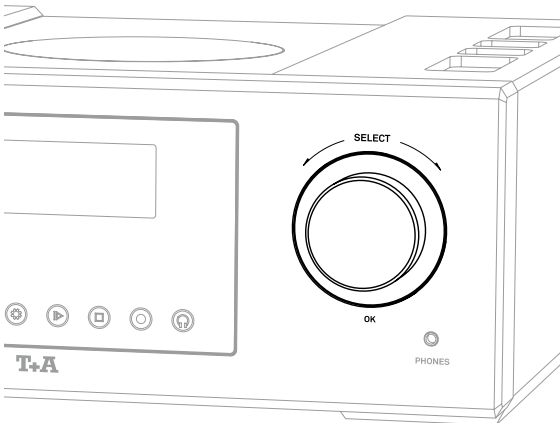

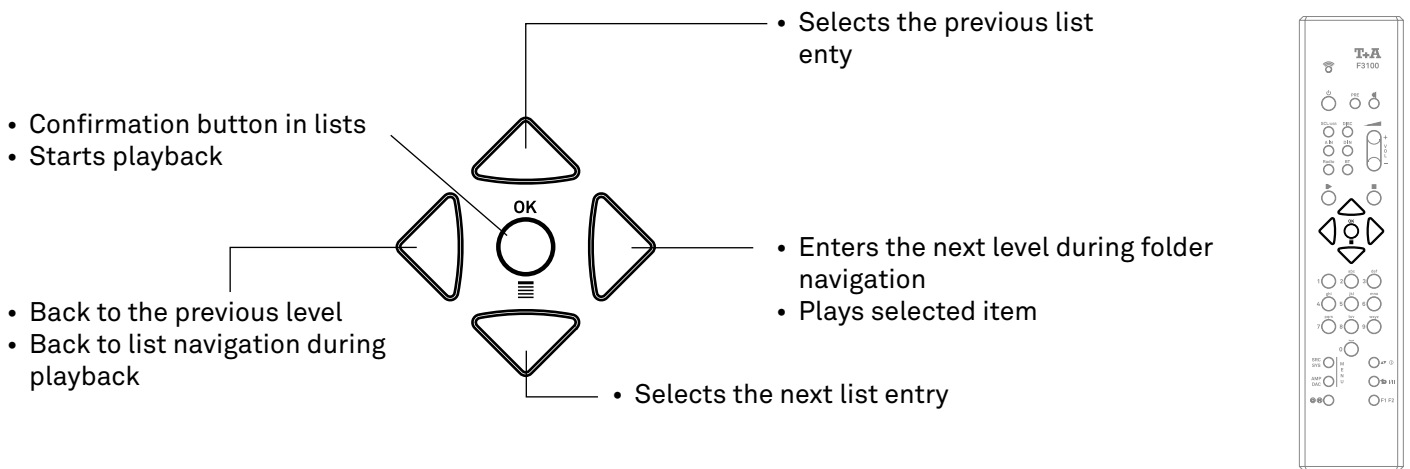

- A folder/title/station/favorite can be selected by turning the SELECT knob on the front panel. The selected list entry is displayed in enlarged form.
- The selected list entry can be opened or played by pressing the SELECT knob depending on the type (folder/title/station etc.).
- A long press on the SELECT knob takes you back to the previous level (if available).

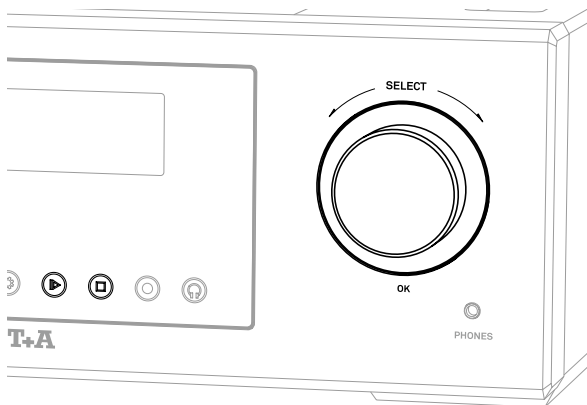

Playback



- A brief press on the SELECT knob starts playback.
- A brief press on the SELECT knob during playback pauses it. Press briefly again to resume.
- You can also use the  button to start and pause playback.
- A long press on the SELECT knob stops playback.
- You can also use the  button to stop playback.

Source FM, DAB:

- Turn the SELECT knob to select the next station.

All streaming sources:

- Turn the SELECT knob to return to the selection list during playback.
- Select the next desired title / station / podcast / etc. for playback and start playback by a brief press on the SELECT knob.

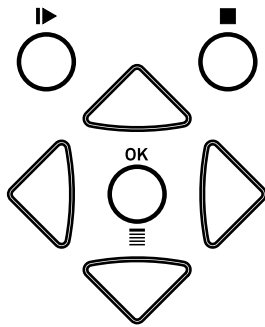

- A brief press on the **OK** / button starts playback.
- Briefly pressing the button during playback pauses it.
- To resume, press the button again briefly.
- A brief press on the button stops playback.
- Use the buttons to select the previous or next title / station during playback.

Source FM, DISC, UPnP, USB, Tidal and Qobuz:

- Press and hold one of the buttons to start the search in upward or downward direction.

Display

The PSD 3100 HV features different screen views for the internal sources (streaming, radio sources, Bluetooth and USB) for playback

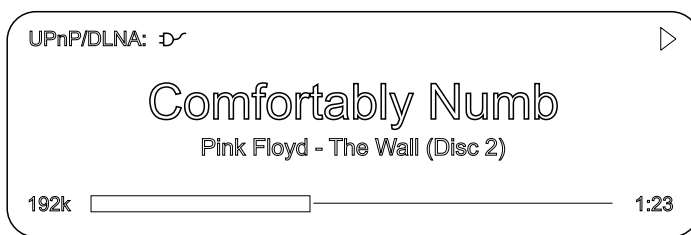

Detailed view:

Display with smaller font and a lot of additional information like bitrate etc.

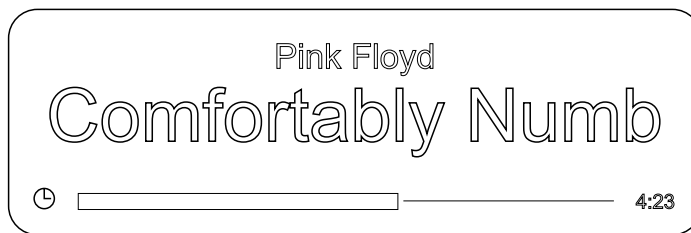

Enlarged view:

Large-format display of the most important information, easy to read even from a greater distance.

The display mode can be changed by a long press on the button of the remote control or by a brief press on the button on the PSD 3100 HV's front panel. The mode change is only visible during playback.

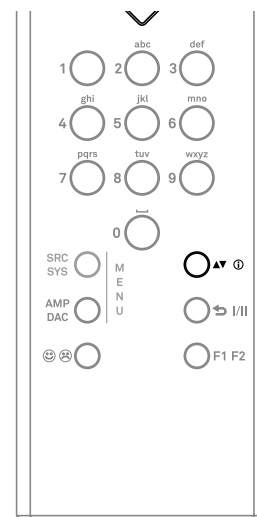
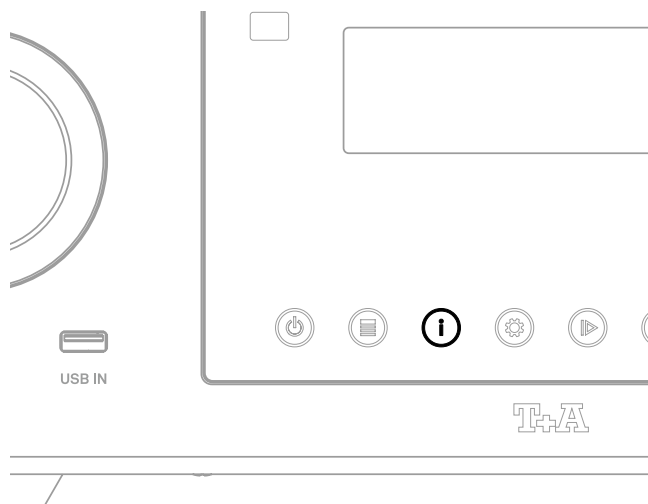

Presets list

General information



The PSD 3100 HV includes the facility to create Presets lists. The purpose of these lists is to store radio stations and podcasts, so that they can be accessed swiftly.

Each of the sources FM radio, DAB radio, and Internetradio features its own Presets list.

Once stored, the Presets can either be selected from the Presets list, or called up directly by entering the program location number. The option of selecting using the location number is particularly useful when you wish to call up Presets when the screen is not in view (e.g. from an adjacent room) or using a house control system.

- i** Presets lists for the various music services (TIDAL etc.) are not supported. Instead it is usually possible to add Presets and Playlists on-line via the provider's account. These can then be called up and played via the PSD 3100 HV.

Calling up the presets list

- The first step is to switch to one of the sources listed above.
- Call up the preset list by a long press on the **OK** /  button on the remote control or by a brief press of the  button on the PSD 3100 HV.

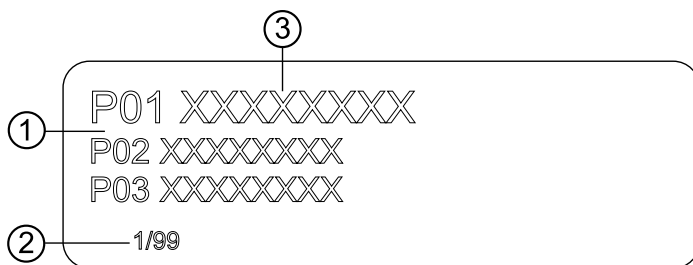



- ① Here the program location number is displayed within the list. Since it is possible to erase individual list items, the numbering may not be continuous.
- ② Position display in the Presets list.
- ③ The selected list entry is displayed in enlarged form.



Adding a preset

If you especially enjoy the piece of music or radio station to which you are currently listening, simply press the  button on the remote control; this action stores the station in the corresponding Presets list.

Erasing an item from the Presets list





Open the Presets list by pressing the  button. Use the  buttons to select the station in the list which you wish to erase, then hold the  button pressed in; this action removes the item from the Presets list.

Play Presets





- Call up the preset list by a long press on the OK button on the remote control or by a brief press of the  button on the PSD 3100 HV.
- Select a stored Preset from the Presets list using the   buttons or by turning the SELECT knob on the PSD 3100 HV. The selected Preset is displayed enlarged.
- A brief press on the OK-button or by pressing the SELECT knob, the Preset is selected for playback.

Sort Presets

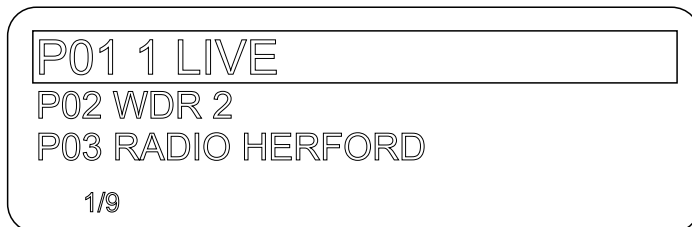
The sequence of items in the Presets list you have created can be altered in any way you wish. This is the procedure for changing the order of the list:

- First, call up the preset list by a long press on the OK button on the remote control or by a brief press of the  button on the PSD 3100 HV.
- Select the Preset that you wish to change the position of with the   buttons on the remote control or by turning the SELECT knob on the PSD 3100 HV. The selected Preset is displayed enlarged.
- Pressing the  button on the remote control activates the sort function for the selected Preset. The Preset is highlighted.



- Now move the activated Preset to the desired position in the Presets list using the   buttons on the remote control or by turning the SELECT knob on the PSD 3100 HV.
- Pressing the  button again deactivates the sorting function. The Preset is now stored at the new position.
- A long press on the OK-button or a brief press on the  button closes the preset list.

 *If you have previously erased a number of Presets, you may well find that some program locations in the Presets list are missing (empty). Nevertheless, the Presets can still be moved to any location in the list!*

Radio operation

General information

The PSD 3100 HV features an FM Tuner (VHF radio) with HD Radio™ technology*, a DAB / DAB+ reception section (digital radio) and also includes the facility to stream Internet radio. The following section describes in detail how to operate the individual radio sources.

HD Radio technology enables radio stations to transmit analogue and digital programmes on the same frequency simultaneously.

The integral DAB+ receiving section is backwards-compatible with DAB, to ensure that you have access to a wide range of stations.

* HD Radio™ technology only available in US-version.

FM Radio

Select the source FM Radio with the source selection button *RADIO* on the F3100 or by turning the *SOURCE / VOLUME* knob on the front panel of the PSD 3100 HV.

Display

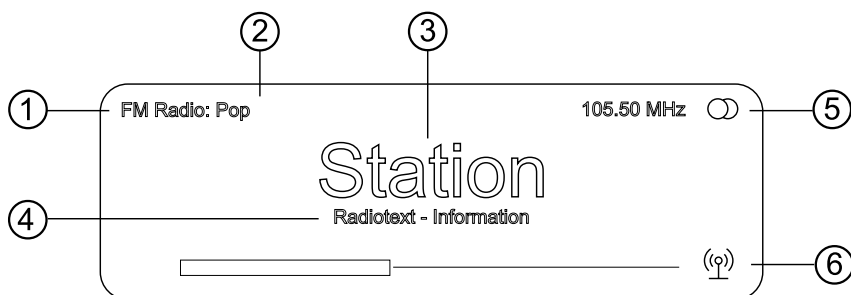

- ① Displays the selected radio source.
- ② Here the music type or style is displayed, e.g. Pop Music.
This information is only displayed if the transmitting station broadcasts it as part of the RDS system. If you are listening to a station which does not support the RDS system, or only supports it in part, these information fields remain empty.
- ③ The frequency and / or the station name is displayed in enlarged form. If a station name is displayed, its frequency is shown in area ⑤.
- ④ These lines display information which is broadcast by the station (e.g. Radiotext).
- ⑤ Display of Stereo ○ / ● Mono
- ⑥ The field strength and therefore the reception quality to be expected from the set transmitting station can be assessed from the field strength.

FM Radio: when receiving an HD Radio broadcast, here the currently selected programme from the total number of programmes available is displayed too (left side), e.g. programme 2 of total 3 available.

Manual station search

Operation by remote control

Press and hold one of the ◀ ▶ buttons on the remote control to start the station search in upward or downward direction. The station search stops automatically at the next station found. By repeatedly short presses on the buttons on the remote control, it is possible to select a specific frequency. Once the desired station has been selected, it can be added to the Favourites list by pressing the 😊☹ button. (see also chapter „Favourite lists“)

Operation at the device

Manual selection of a specific frequency is also possible via the SELECT knob on the device. By pressing the SELECT knob several times, if necessary, you can switch between the functions of the SELECT knob for a short time. The currently selected operating mode is shown at the bottom left of the display (only in the detailed display setting). The following functions can be selected:

Display indicator	Function
Freq	Manual frequency tuning
Fav	Selecting a stored favourite
None (Standard setting)	Selecting a station from the station list
HD	HD Radio programme selection (if available)

i The method of searching for an HD Radio station is the same as for an analogue FM station search. As soon as you select a station with a HD Radio programme, playback automatically switches to the digital programme.

Automatic station search

A brief press on the ⚙ button on the PSD 3100 HV's front panel or a brief press on the ^{SRC}_{SYS} button on the remote control opens the station list menu. The following menu items are available:



- If you wish to create a new station list, select the item “Create new list” and confirm your choice with **OK** / ☰.
- The station search begins, and automatically searches for all radio stations which the machine is able to pick up.
- If you wish to update an existing list, select the item “Add new stations”.
- The menu item “Sort stations by ...” allows you to sort the stored list by any of several criteria.

Mono / Stereo selection

By a long press on the ⏮ / ⏭ button of the remote control, the FM tuner of the PSD 3100 HV can be switched between stereo and mono reception. The reception mode is shown in the display:

Switching Radio text on and off



The Radio text function can be switched on and off by long presses on the ▲▼ ⓘ button on the remote control handset. Repeatedly if necessary.

DAB Radio

Select the source *DAB Radio* with the source selection button *RADIO* on the F3100 or by turning the *SOURCE / VOLUME* knob on the front panel of the PSD 3100 HV.

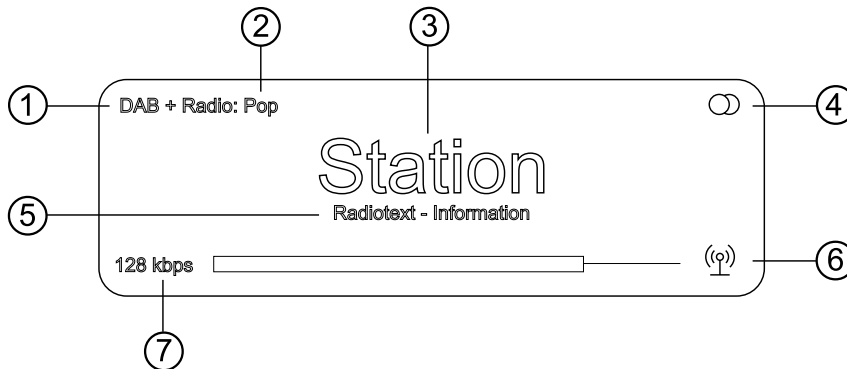
Display



- ① Displays the selected radio source.
- ② Here the music type or style is displayed, e.g. Pop Music.
This information is only displayed if the transmitting station broadcasts it as part of the RDS system. If you are listening to a station which does not support the RDS system, or only supports it in part, these information fields remain empty.
- ③ Display of the station name
- ④ Display of Stereo  /  Mono
- ⑤ These lines display information which is broadcast by the station (e.g. Radiotext).
- ⑥ The field strength and therefore the reception quality to be expected from the set transmitting station can be assessed from the field strength.
- ⑦ Bit-rate of the broadcasting station when listening to DAB radio.
* The higher the bit-rate, the better the station's sound quality.

Automatic station search

A brief press on the SRC button on the PSD 3100 HV's front panel or a long press on the  button on the remote control opens the station list menu. The following menu items are available:



- If you wish to create a new station list, select the item "Create new list" and confirm your choice with **OK** / .
- The station search begins, and automatically searches for all radio stations which the machine is able to pick up.
- If you wish to update an existing list, select the item "Add new stations".
- The menu item "Sort stations by ..." allows you to sort the stored list by any of several criteria.

Internet Radio

Select the source *Internet Radio* with the *RADIO* source selection button on the F3100 or by turning the *SOURCE / VOLUME* knob on the front panel of the PSD 3100 HV.

Display

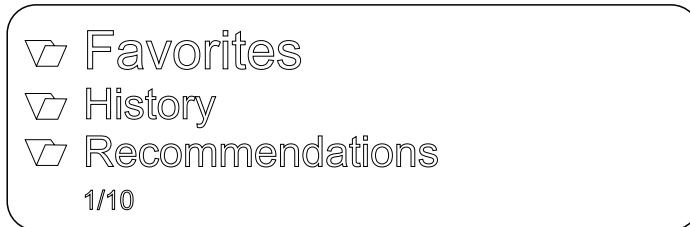

Search function

- To call up the search function, press the ▲▼ ⓘ button.
- A pop-up window with the message *Search* appears in the display. While the pop-up window is displayed, enter a letter using the ▽△ buttons on the remote control. Press the button repeatedly until the desired letter appears in the display.
- To delete a letter, press the ◀ button.
- Press the **OK**/☰ button to start the search.
- After a short delay, a list with the search results appears.

Favorites

In addition to the presets list provided by the device (see also chapter Presets lists on page 34), the Internet radio source also has a Favorites folder in the root folder of the Internet radio source. This Favorites folder is provided by the Internet radio provider and is independent of the presets list on the device itself.

To save a favorite in this folder, tap the ☆← icon in the T+A Music Navigator (G3) app during playback. To delete the favorite from the folder, tap the ☆→ icon.

UPnP, Music services and USB

General information

The PSD 3100 HV includes a streaming client (SCL).
This enables music playback from network servers (NAS), a directly connected USB storage device or music streaming services e.g. Tidal and Qobuz.

 *To make use of music services you may need to take out a paid subscription with the appropriate provider.*

*Use of music services requires the input of access data (username and password. These access data can be stored separately for each provider in the **Music services** menu item within the settings menu (Page 29).*

*The memory medium can be formatted with any of the following file systems:
FAT16, FAT32, NTFS, ext2, ext3 or ext4.*

The exact form of the list format and the preparation of the content depends mainly on the capabilities of the server / music streaming service.

Source selection

Choose the desired listening source by pressing the *SCL / USB* -button on the F3100 (repeatedly if necessary), until the source you want to hear to is displayed on the screen. To select the source on the front panel of the PSD 3100 HV turn the *SOURCE / VOLUME* -Knob.

Display

 Folder
 Folder
 Folder
1/XX Track
 Track
 Track
1/XX

Spotify Connect

Playback

The PSD 3100 HV supports playback via Spotify.

Use your phone, tablet or computer as a remote control for Spotify.

Go to spotify.com/connect to learn how



- Connect the PSD 3100 HV and the Smartphone/Tablet to the same network.
- Start the Spotify App and log in to Spotify.
- Start the playback via the Spotify App
- The PSD 3100 HV appears in the app in the list of available devices.
- To start playback on the PSD 3100 HV, select it by tapping on the PSD 3100 HV.
- Playback now starts via the PSD 3100 HV.

Apple AirPlay

Playback

- The PSD 3100 HV supports playback via Apple AirPlay.
- To do this, connect the PSD 3100 HV and the smartphone/tablet to the same network.
- Start the desired AirPlay-compatible app (e.g. iTunes or similar).
- Start playback.
- PSD 3100 HV appears in the app, in the list of available devices
- To start playback on the PSD 3100 HV, select it from the list by tapping it.
- The source on the PSD 3100 HV will automatically switch to AirPlay and playback will start on the PSD 3100 HV.

You can find more information at: <https://www.apple.com/airplay/>



Amazon Music

Registration

The PSD 3100 HV supports playback of Amazon Music.

The device must be registered first in so that you can use the music from Amazon Music.

It requires an Amazon account and you need to sign up for Amazon Prime or Amazon Music Unlimited.

For more information, visit the Amazon website. Amazon Music is available in many countries.

You can check if Amazon Music is available in your country at <https://music.amazon.com/>.

Here you can get more information.



Playback

The operation is done via the T+A Music Navigator App (G3) or directly on the device as described in the chapter Operating the sources on page 31.

Tidal Connect

Playback

The PSD 3100 HV supports playback via TIDAL connect.

Use your smartphone, tablet or computer as a remote control for TIDAL.

Visit <https://tidal.com/connect> to learn more.

- To start playback from your mobile device, connect the PSD 3100 HV and smartphone/tablet to the same network.
- Launch the Tidal app and log in.
- Start playback via the Tidal app.
- The PSD 3100 HV appears in the list of available devices.
- To start playback on the PSD 3100 HV, select it by tapping on it.
- The source on the PSD 3100 HV automatically switches to TIDAL Connect and playback starts on the PSD 3100 HV.



Playback with Roon

General information

The PSD 3100 HV supports playback via Roon.

Roon is a fee required software solution that manages and organizes your music stored on a server. Furthermore the streaming service TIDAL and Qobuz can be integrated.

Playback

The operation is exclusively done via the Roon-App. The PSD 3100 HV is recognized as a playback device (client) and can be selected for playback in the app. As soon as Roon is used for playback, *ROON* appears on the PSD 3100 HV display as source.

Further information about Roon and its operation can be found at:
<https://roonlabs.com>

Bluetooth

General information

The PSD 3100 HV integral Bluetooth interface provides a means of transferring music wirelessly from devices such as smart-phones, tablet PCs, etc. to the PSD 3100 HV.

Source selection

Select the source *Bluetooth* with the source selection button *BT* on the F3100 or by turning the *SOURCE / VOLUME* knob on the front panel of the PSD 3100 HV.

Setting up audio transfer

Before music from a Bluetooth-capable device can be played through the PSD 3100 HV, the external device must first be registered to the PSD 3100 HV. As long as the PSD 3100 HV is switched on and no device is connected, it is always ready to receive. In this state the screen displays the message *not connected*.



To establish a connection, carry out the following steps:

- Start the search for Bluetooth devices on your mobile device.
- If the PSD 3100 HV is found, select it for pairing.

If the connection is successfully established, the device name of the connected device is shown at the bottom right of the display.

Playback

Information on the piece of music currently being played is displayed on the screen of the PSD 3100 HV if this function is supported by the device connected to the unit.

The behaviour and method of operating the connected mobile device are determined by the device itself. Usually, playback can be controlled via the buttons on the remote control (start/stop, pause, skip).

 *To control the PSD 3100 HV the mobile device must conform to the Bluetooth AVRCP protocol.*



D / A converter operation

General information

The PSD 3100 HV can be used as a high-quality D/A converter for other devices such as computers, streamer, digital radios etc. which are fitted with poor-quality converters or no converter at all. The PSD 3100 HV features two optical, three electrical S/P-DIF digital inputs and two HDMI-inputs on the back panel to allow this usage.

The USB-DAC input on the back panel permits to use the PSD 3100 HV as D/A converter for computers.

D/A Converter Operation

Choose the digital input to which you have already connected the source device which is to be played.

As soon as the source device delivers digital music data, the PSD 3100 HV automatically adjusts itself to the format and sampling rate of the signal, and you will hear the music.

 *During D/A converter operations the PSD 3100 HV integral screen displays the characteristics of the digital input signal.*

S/P-DIF (Digital IN 1 ... IN5)

You can connect devices with electrical co-axial, BNC, AES-EBU or optical output to the digital inputs of the PSD 3100 HV. At inputs DIGITAL IN 1 to DIGITAL IN 5 the PSD 3100 HV accepts digital stereo signals conforming to the S/P-DIF norm, with sampling rates of 32 to 192 kHz.

HDMI

At the HDMI 1 and HDMI 2 inputs, the PSD 3100 HV accepts digital PCM encoded stereo signals with sampling rates of 44.1 ... 384 kHz (32 bit) and DSD data with a sampling rate of DSD 64/DSD 128.

If a TV is connected to the HDMI OUT output, the TV sound can be transmitted to the PSD 3100 HV via ARC (Audio Return Channel) if supported by the TV.

If necessary, the PSD 3100 HV can be switched to By-Pass mode by a long press on the  button. In this case, the sound is played back on the TV.

 *To use the ARC function, the TV must support it and the PSD 3100 HV must be connected to an ARC compatible input.*

USB DAC

At the USB DAC inputs the PSD 3100 HV accepts digital PCM-encoded stereo signals with sampling rates of 44.1 to 768 kHz (32-bit) and DSD data with sampling rates of DSD64, DSD128, DSD256 and DSD512.

Playback from a computer (USB-DAC)

Minimum system requirements

Intel Core i5 or higher or a comparable AMD Processor, 4 GB RAM, USB 2.0 Interface, Microsoft Windows 10, 8.1, 8 or 7, Linux with 4.4 Kernel or higher or MAC OS X 10.13.6 or later version

Driver installation for Windows

For playback via USB, from a connected Windows PC, specific driver software is required on the computer. The required drivers and a detailed installation manual are available for download on our homepage at <http://www.ta-hifi.com/support>.

No drivers are required when using a computer with Linux or Mac OS.

System settings

A number of system settings have to be altered if you wish to operate PSD 3100 HV with your computer. These changes must be made regardless of the operating system. The installation instructions provide detailed information on how and where the settings are to be changed.

Playback

- If necessary, first reduce the set volume.
 - Switch on the computer.
 - Select the USB input using the source selection buttons on the device or the remote control.
 - If necessary, select the PSD 3100 HV as the output device in the system settings of the operating system.
 - Open the playback software on the computer.
-

 *Do not disconnect the USB connection during operation. Do not turn off the PSD 3100 HV during playback. This can lead to malfunctions and crashes.*

If there is a malfunction during playback, restart the computer.

The playback of files stored on the computer cannot be controlled by the PSD 3100 HV or F3100.

The playback of DSD files is restricted to a maximum of DSD 256 on Apple MAC computers, as Apple only supports playback in DoP format and does not support native streaming.

HDMI playback

Connection variants

Depending on the usage, various options are available for connecting the PSD 3100 HV via HDMI to source devices such as a BluRay player and a television, surround receiver, beamer or similar devices. Some sample configurations are shown below. The table gives an overview about the functions available for the various configurations (depending on the devices used).

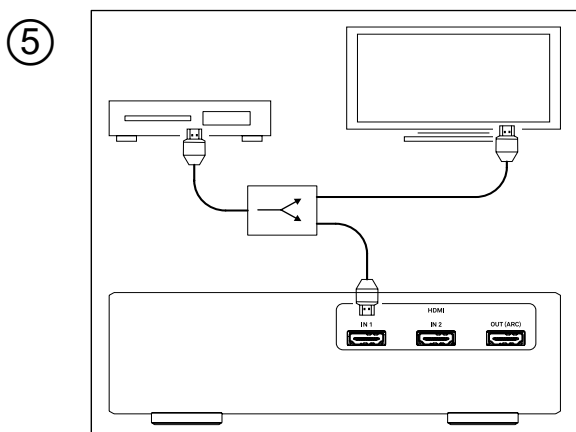
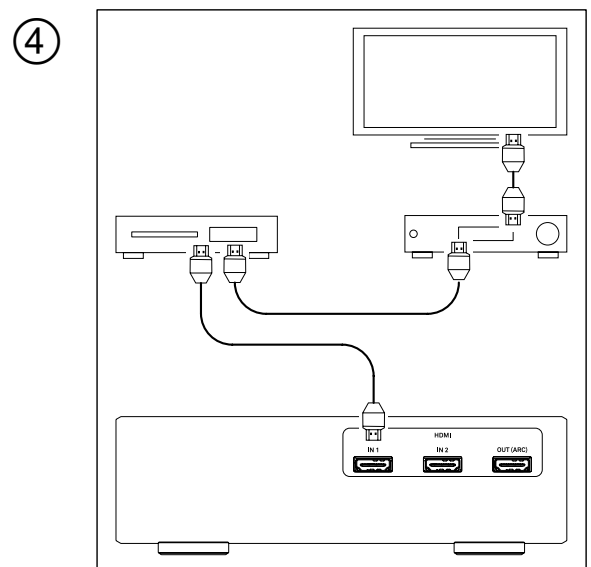
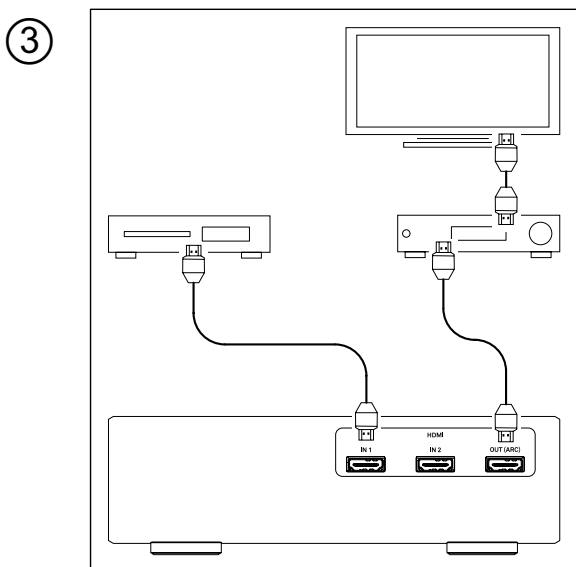
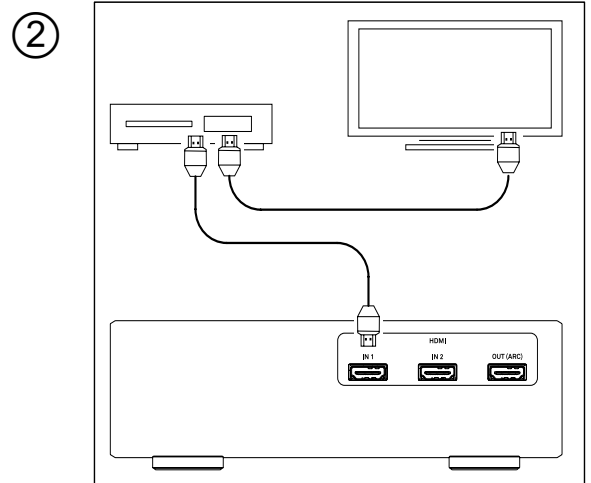
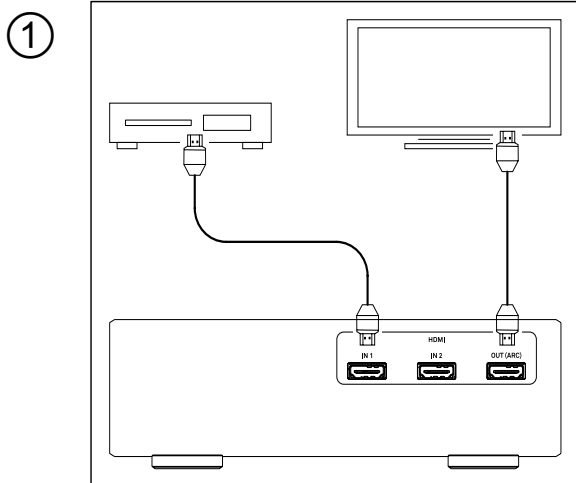

	CEC	ARC	DSD	Picture in standby
①	✓	✓	✓	-
②	-	-	✓	✓
③	✓	-	✓	-
④	-	-	✓	✓
⑤	-	-	✓	✓

CEC = Automatic input switching + volume control; ARC = TV sound via PSD 3100 HV; DSD = DSD playback; Picture playback in standby = playback from source device to TV set while PSD 3100 HV is switched off

Compatibility information

Due to the large number of different versions of the HDMI standard, a general compatibility between the devices cannot be guaranteed. Not all manufacturers implement all functions in the same way. Please refer to the user manual of the respective device to find out whether the desired function is available.

i To use the ARC (Audio Return Channel) function, the TV must support it and the PSD 3100 HV must be connected to an ARC compatible input of the TV.

Settings

HDMI Bypass

(Tone settings)

This menu item allows you to select whether the audio signal at the HDMI connections HDMI 1 and HDMI 2 is to be played back by the PSD 3100 HV, or whether it is passed on for playback via a device connected to the HDMI output.

i Switch on the HDMI bypass function if the PSD 3100 HV is connected between the source device and the television / surround amplifier, and you wish to play back the sound through the television or surround amplifier.

Playback

Since the PSD 3100 HV is designed for pure stereo playback, only 2-channel PCM or DSD64/DSD128 encoded material can be played back via the HDMI inputs of the PSD 3100 HV. For playback via the PSD 3100 HV, the configuration of the HDMI output at the source device may need to be changed. Set the HDMI output to PCM output and activate DSD playback via HDMI if available. Always select the stereo track in the menu of the inserted disc.

If you wish to play back a disc in surround format (e.g. Dolby Digital or DTS) via the television or a surround amplifier, the sound can be passed on from the PSD 3100 HV to that unit (see HDMI Bypass settings).

Display of format and sampling rate

Format	Playback via PSD 3100 HV	For example
PCM (32...192 kHz)	YES	CD, DVD or BluRay with 2-channel stereo sound, e.g. concert recording
DSD (DSD 64 / 128)	YES	Playing a SACD (stereo track)
Bitstream	NO	Playback of a DVD or BluRay with surround encoded movie or similar.
Multi Ch.	NO	

Troubleshooting

Many problems have a simple cause and a correspondingly simple solution. The following section describes a few difficulties you may encounter, and the measures you need to take to cure them. If you find it impossible to solve a problem with the help of these notes please disconnect the unit from the mains and ask your authorised T+A specialist dealer for advice.

Machine does not switch on

Cause:

Mains leads not plugged in correctly.

Remedy:

Check connection, push connector in firmly.

Device responds correctly to operation via the buttons directly on the device, but cannot be operated by remote control

Cause:

The battery of the F3100 remote control is completely discharged.

Remedy:

Insert a new battery as described in the Remote control chapter.

The RDS station name and/or the Radio Text does not appear in the display.

Cause 1:

Reception is poor, interference is severe, or the field strength (signal strength) is low.

Remedy:

Select only those stations which can be received with a strong signal: hiss-free and without interference.

Cause 2:

The display view is in the large format setting.

Remedy:

Switch to the detailed display view using the **i** key on the device. If necessary, tap several times to switch on the radio text.

One or more sources cannot be selected via the source selection buttons on the device and the remote control

Cause :

The source in question has been disabled.

Remedy:

Enter the system settings menu and enable the disabled source.

Transmission interruptions occur when listening to internet radio stations.

Cause:

The capacity of the internet radio station's server is at its limit.

Remedy:

Choose a different station.

The streaming client cannot connect to a network.

Cause 1 (cable LAN):

Network cable not properly connected

Remedy:

Connect network cable, check connection to router

Cause 2 (wireless LAN):

WLAN antennas not connected or placed in a location with bad reception quality

Remedy:

Connect WLAN antennas properly and find a location with good reception quality.

Set the transmission power output of your WLAN router to maximum.

Try to establish a network connection first in a location close to the WLAN router. If this succeeded try to connect to WLAN from a more remote location. Experiment with antenna position and try to find a location with better reception quality.

Cause 3 (wireless LAN):

WLAN reception quality bad (low field strength). Possibly too much attenuated by walls/ceilings on the transmission path.

Remedy:

Optimize location of receiver and transmitter antennas.

Alternative:

If transmission problems persist a so called 'Power Line' network might be good alternative to establish a good and stable network connection.

The best, safest and most secure network however will always be a cable LAN network.

Cause 4:

Network parameters not properly configured.

Remedy:

Configure the network parameters correctly (see chapter 'Network configuration').

Cause 5 (operation without network connection):

For proper operation the PSD 3100 HV needs at least one properly connected network device. This can be a LAN or WLAN network or a USB storage device.

Remedy:

If the PSD 3100 HV shall be operated without network (LAN / WLAN) please connect at least a USB stick.

USB Storage device is not recognised

Cause 1:

The storage device (especially USB hard discs without separate power supply) draws more electrical current from the USB interface than is permitted by the USB standard.

Remedy:

Only use USB storage devices that conform to the USB standard or use storage devices with own power supplies.

Cause 2:

The storage device is not formatted with an appropriate file system.

Remedy:

The PSD 3100 HV accepts storage devices with FAT16 or FAT32, NTFS, Ext2, Ext3, Ext4 file systems.

Notes on energy saving

General information

The PSD 3100 HV satisfies the requirements of the latest directives concerning energy-saving measures (EuP directive). The modern design of the mains power supply makes an important contribution to this. The internal micro-processor constantly ensures that sub-assemblies which are not currently required are automatically switched off. The micro-processor itself operates in stand-by mode at a relatively low clock speed, and only responds to the remote control receiver.

In stand-by mode the current drain of the PSD 3100 HV is less than 0.5 Watt.

If you intend not to use the device for a long period, it should be disconnected from the mains socket, i.e. the mains plug should be withdrawn from the wall socket.

Automatic power down function

The device features an automatic power-down function. If the PSD 3100 HV detects no operation or no music signal for a period longer than 90 minutes, it automatically switches to stand-by mode

 *In countries outside the EU, in which the EuP directive has no validity, the automatic power-down feature can be disabled if necessary. See chapter „System settings“.*

Legal Information

General information

This product contains software in form of object code that is partially based on free software under different licenses. Details of the licenses used can be viewed on the device website using an Internet browser.

Show licenses

For details regarding the used licenses, please visit our website by entering the following link:
<https://www.ta-hifi.de/support/license-information-g3/>

Furthermore, the address can be called up at any time as follows:

- Call up the system configuration menu by pressing the button on the PSD 3100 HV.
- Then navigate to the menu item Device Info. Open it by pressing the SELECT button and navigate to the menu item Legal information and open it with by pressing the SELECT button again.
- The above Internet address is displayed in the pop-up window that now opens.

Firmware update

General information

The PSD 3100 HV is software-based in many functions. New updates and functions will be made available from time to time.

We recommend updating the software before using the PSD 3100 HV for the first time. To keep the device always up to date later, new updates should be checked occasionally.

The following section describes the exact method of updating the firmware in detail.

 *To avoid malfunctions after updating the PSD 3100 HV, all devices in the system should always be checked for any available updates and installed if they are available.*

Update procedure

- The basic requirement is a functioning network with router and access to a broadband Internet connection; the system must be operating.
- Switch the machine on.
- Call up the System menu by pressing the  button on the front panel.
- Rotate the SELECT knob on the front panel to select the *Device info* menu point, and confirm your selection by pressing the SELECT knob.
- Select the *Update* menu point by rotating the SELECT knob, then press the SELECT knob to confirm your choice.
- The select option *WEB* should now be active (highlighted).
- The firmware update can now be started by pressing the SELECT knob.
- The screen displays the current state of progress of the update.
- Once the update has been completed (duration 10 - 30 minutes) the device automatically switches itself off and restarts.
- When the machine has restarted, the update is complete.
- To ensure that the update was successful, access the *Device Info* menu point mentioned above, and check the new firmware status.

 *Instead of starting the update process directly on the device, it is also possible to operate the update process via the F3100 remote control.*

Connection and wiring

Standard system configuration

PDT 3100 HV

PSD 3100 HV

A 3000 HV

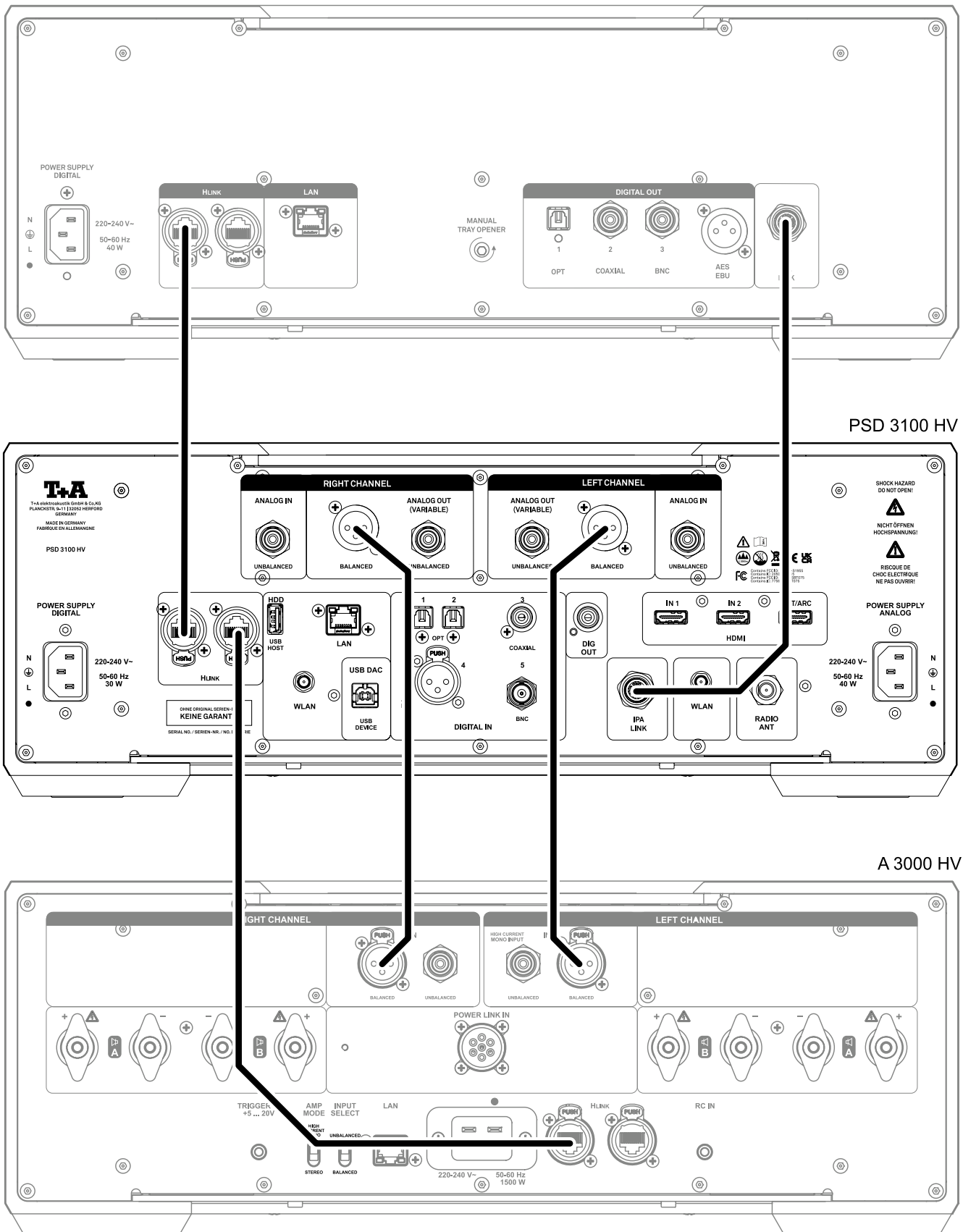

PDT 3100 HV

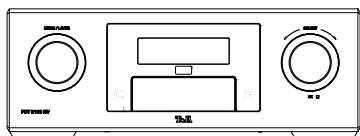

HLink

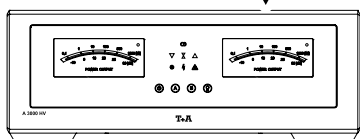

A 3000 HV

HLink

TV.

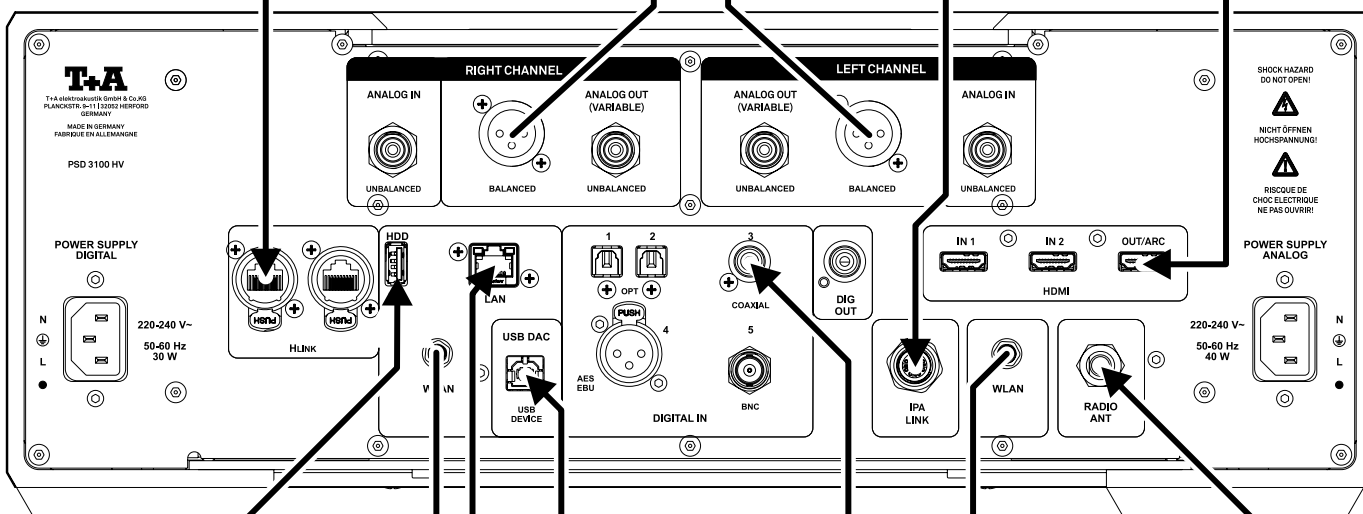

USB storage

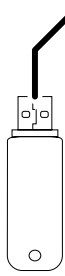

Computer
USB DAC

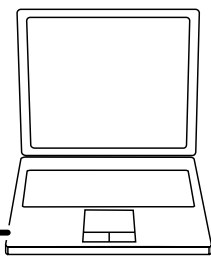

Network storage

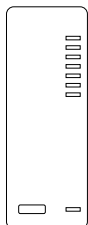

Internet access LAN or WLAN

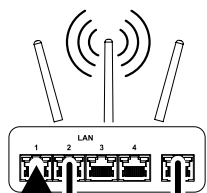

Digital source device

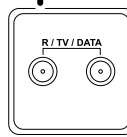

87,5 - 108 MHz
+ 174 - 230 MHz

Specifications

Pre-amplifier	
Frequency response +0 / -3dB	0,5 Hz - 300 kHz
Signal / noise ratio	108 / 112 dB
THD Intermodulation Channel separation	< 0,001 % < 0,001 % < 108 dB
Nominal input sensitivity	
High level input (RCA)	250 mV _{eff} ... 6 V _{eff} / 24 kOhm
Analogue output RCA XLR	nom 1 V _{eff} , max 9,5 V _{eff} / 20 Ohm nom 1,45 V _{eff} , max 19,6 V _{eff} / 40 Ohm
Headphone output	4,4 mm Pentaconn (6 Ohm)
Connections	
Digital inputs	<p>1 x AES-EBU 32...192 kHz / 16-24 Bit 4 x S/P-DIF: 1 x Standard Coax, 1 x high quality BNC 32...192 kHz / 16-24 Bit, 2 x optical TOS-Link 32...192 kHz / 16-24 Bit. 1 x USB DAC: Device-Mode up to 768 kSps (PCM) and DSD 512*, supports asynchronous data transfer. *DSD 512 only with Windows PC with appropriate driver or a Linux PC with kernel version 4.4 or higher.</p> <p>2 x USB Master-Mode for USB-Mass storage (Stick or HDD) 2 x HDMI IN, 1 x HDMI OUT with ARC 1 x IPA (LVDS) LAN, FM, 2 x H-Link</p>
WLAN	<p>IEEE 802.11a/b/g/n/ac/ax 2x2 MIMO 2.412 – 2.472 GHz (2.4GHz ISM Band, 13 Channels) Channel 1 – Channel 13 North America FCC, Japan MIC, Europe ETSI 20MHz bandwidth 5.180-5.825 GHz (5GHz UNII-1/2/3 Band, 24 Channels) North America (IC and FCC): 5.180-5.600 GHz, 5.650-5.825 GHz Europe, Japan (ETSI and MIC): 5.180-5.700 GHz</p> <ul style="list-style-type: none"> • max gain in 2.4GHz band: 3.2dBi • max gain in 5 GHz band: 4.25dBi up to 17dBm (at antenna terminal).
D/A-Converter	
	<p>PCM Double-Differential-Quadruple-Converter with four 32-Bit Sigma-Delta D/A-Converters per channel. 705,6 / 768 kSps conversion rate</p> <p>DSD T+A-True-1Bit DSD D/A-Converter, up to DSD 512 (22,4 / 24,5 MHz), native bitstream</p>
Upsampling	T+A-Signalprocessor – synchronous upsampling with 4 selectable oversampling algorithms. FIR short, FIR long, Bezier/IIR, Bezier
Analogue filter	Phase-linear Bessel filter 3rd order, switchable with 60 or 120 kHz cut off frequency

Frequency response	PCM 44.1 kSps	2 Hz - 20 kHz	
	PCM 48 kSps	2 Hz - 22 kHz	DSD 64: 2 Hz - 44 kHz
	PCM 96 kSps	2 Hz - 40 kHz	DSD 128: 2 Hz - 60 kHz
	PCM 192 kSps	2 Hz - 80 kHz	DSD 256: 2 Hz - 80 kHz
	PCM 384 kSps	2 Hz - 100 kHz	DSD 512: 2 Hz - 100 kHz
	PCM 768 kSps	2 Hz - 120 kHz	
THD S/N ratio Channel separation	< 0.001 % > 117 dB > 110 dB		
Streaming Client	Streaming client module 3 rd generation with Quad Core processor		
Tuner			
Internet Radio	Airable Internet Radio Service (> 11000 Stations).		
FM, FM-HD	87,5 - 108 MHz; sensitivity 1 µV; S/N > 65 dBA.		
DAB, DAB+	168 -240 MHz (Band III); Sensitivity 2,0 µV, S/N > 96 dBA.		
Features	RDS/RDBS, Stationname (PS), Programm type (PTY), Radiotext (RT)		
Bluetooth	A2DP (Audio), AVRCP 1.4 (Control) / aptX [®] HD, SBC, AAC		
Mains	2 x 110-120 V or 220-240 V, 50-60 Hz. Operation: 30 W digital / 40 W analogue, Standby: < 0,5 W.		
Dimensions (H x W x D), Weight	17 x 46 x 46 cm / 6,7 x 18,1 x 18,1 inch , 26 kg / 57,3 lbs		
Accessories	2x power cord, remote control F 3100, BNC adapter, 2x WLAN antennas		
Finishes	silver laquer 47 or titanium laquer 64		

We reserve the right to alter specifications.



T+A elektroakustik GmbH & Co. KG
Planckstraße 9 – 11
32052 Herford | Germany

T +49 5221 76760
F +49 5221 767676

info@ta-hifi.com
www.ta-hifi.com