



# Incredible Immersion with Ultra-Narrow Bezel

## VL5F Series

The VL5F series provides all-encompassing screen immersion thanks to its ultra-narrow 3.5 mm bezel-to-bezel, while its outstanding IPS panel delivers a clear image from any angle. With its extremely attractive and highly functional design, it can be used to deliver advertising and information in a variety of business environments.

# Incredible Immersion with Ultra-Narrow Bezel

## VL5F Series

### Achieving Incredible Immersion

#### Seamless Large Screens with Ultra-Narrow Bezel

The ultra-narrow bezel creates a visually stunning digital wall to effectively deliver dynamic content and immerse the viewers. The large screen it generates is enough to captivate the attention of passersby.



#### Image Gap Reduction

The VL5F series includes an image improvement algorithm that can reduce image gaps among tiled displays when playing back videos. Objects located on the bezel boundaries are adjusted for a seamless viewing experience.

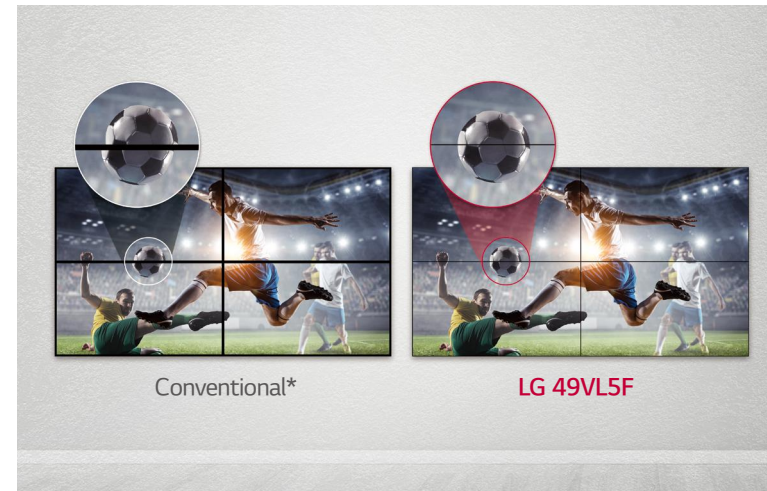

\* The "Conventional" refers to displays which do not include an image improvement algorithm.

# Incredible Immersion with Ultra-Narrow Bezel

## VL5F Series

### Vivid and Dynamic Picture Quality

#### Higher Viewing Angle

Large screens are usually positioned higher than human-eye level, making uniform picture quality essential for video walls. The viewing angle of the VL5F series is high enough to display vivid colors throughout the screen with no distortion.



45°\* High Viewing Angle

#### Wider Viewing Angle

It is well known that LG IPS panel technology enables better control of liquid crystals, which in turn allows the screen to be viewed from virtually any angle. Because of this, the VL5F series captures the attention of and captivates more viewers with lifelike colors, regardless of their viewing position.

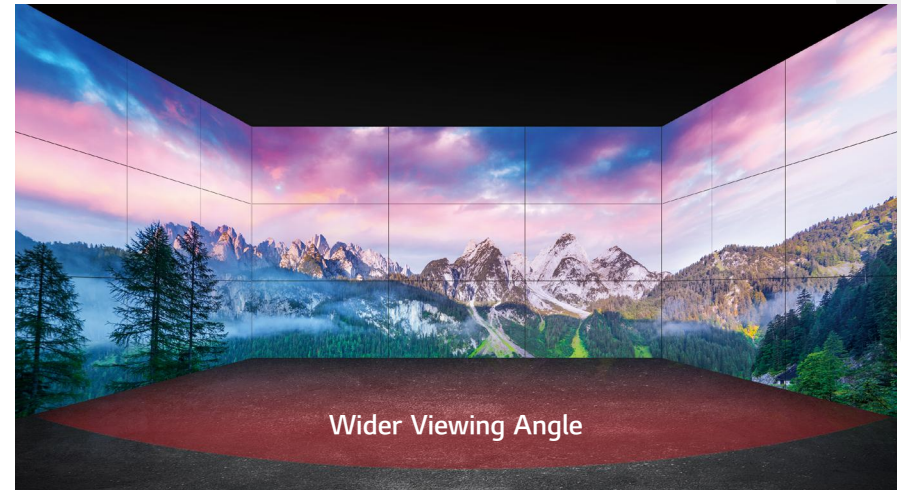

\* Results based on in-house testing. Actual test results may differ depending on environment and measuring equipment.

# Incredible Immersion with Ultra-Narrow Bezel

## VL5F Series

### User Convenience

#### Easy Color Adjustment

Depending on the content, the color temperature of the display can be easily adjusted in increments of 100K using a remote control.

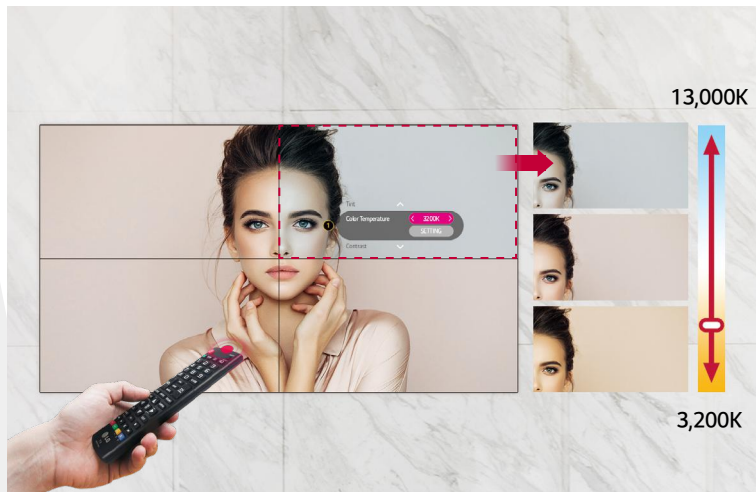

#### Simple White Balance Adjustment

In conventional video walls, white balance was adjustable only in “full-white” mode, but the VL5F series allows you to modify each value of grey scale to achieve more detailed and precise white balance adjustment.

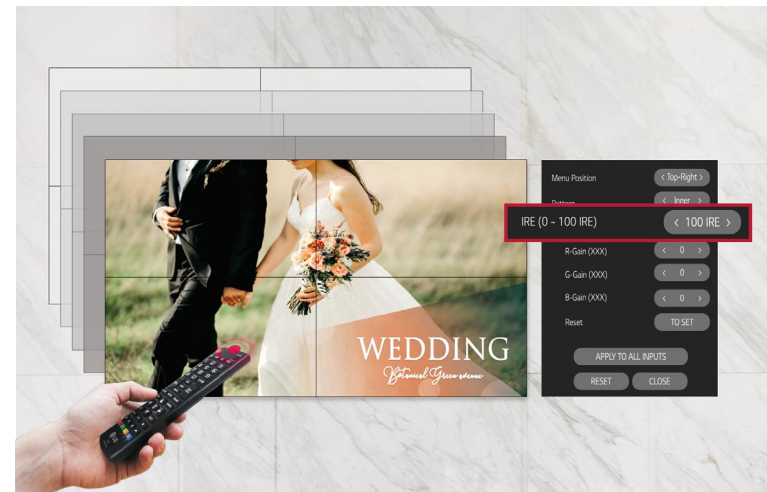

# Incredible Immersion with Ultra-Narrow Bezel

## VL5F Series

### User Convenience

#### User-Friendly Menu Structure

The menu structure has been optimized for commercial use. It simplifies approach flows and groups similar functions together, adopting a more intuitive GUI for ease of use. This way, users can avoid having to do trial-and-error when exploring desired functions and managing displays.

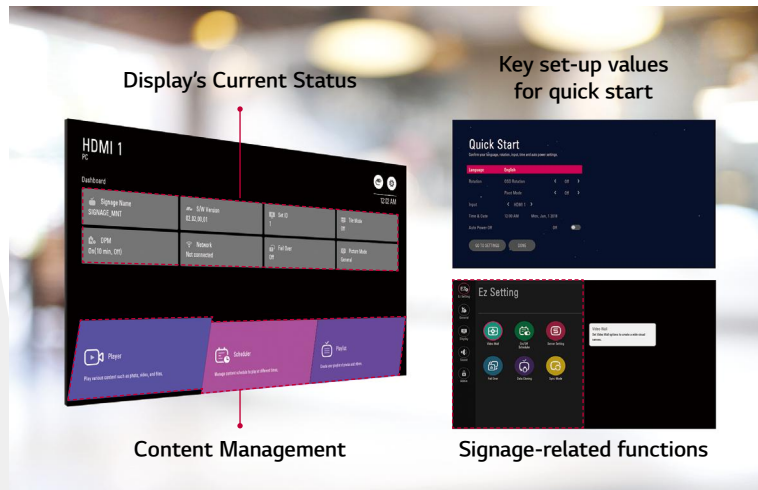

#### Intuitive GUI

The GUI(Graphic User Interface) is carefully designed with a four-way navigation remote control that lets users easily switch to other settings. Also, it adopts a larger font for better visibility, which is necessary when users want to control displays from relatively far distances.

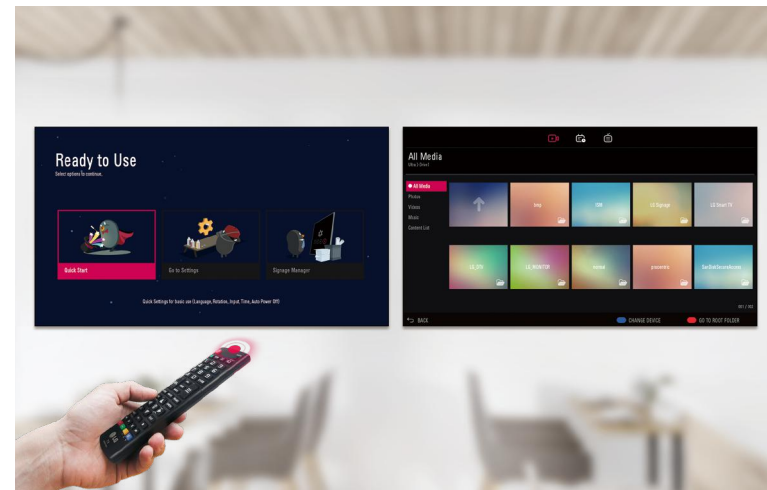

## DIMENSION (unit: mm)

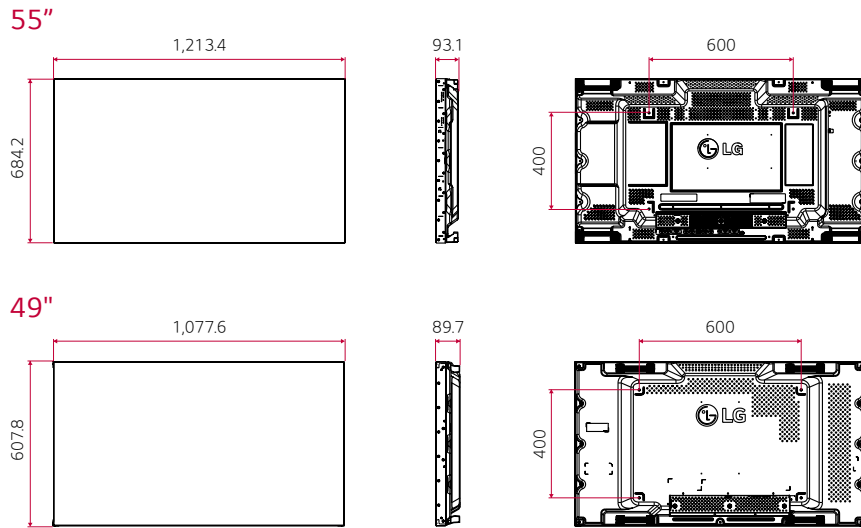

## CONNECTIVITY

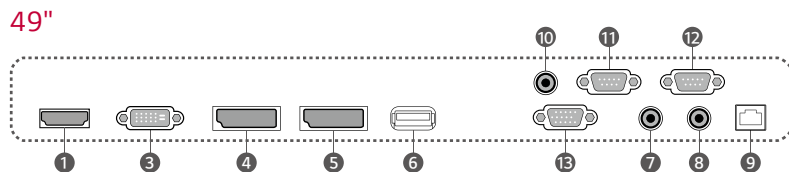
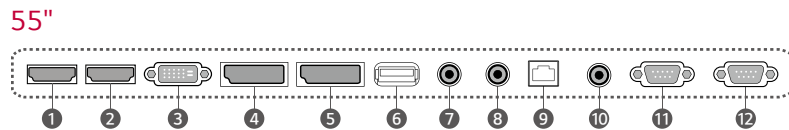

- ① HDMI IN 1      ④ DP IN      ⑦ AUDIO IN      ⑩ IR IN      ⑬ RGB IN
- ② HDMI IN 2      ⑤ DP OUT      ⑧ AUDIO OUT      ⑪ RS232C IN
- ③ DVI-D IN      ⑥ USB 2.0 IN      ⑨ LAN IN      ⑫ RS232C OUT



## SPECIFICATION

		55VL5F	49VL5F
Panel	Screen Size	55"	49"
	Panel Technology	IPS	IPS
	Native Resolution	1,920 × 1,080 (FHD)	1,920 × 1,080 (FHD)
	Brightness (Typ.)	500 nit	450 nit
	Contrast Ratio	1,200 : 1	1,300 : 1
	Dynamic CR <sup>1)</sup>	500,000 : 1	500,000 : 1
	Color Gamut	NTSC 72 %	NTSC 72 %
	Viewing Angle (H × V)	178 × 178	178 × 178
	Color Depth	1.07 Billion Colors (10 bit)	1.07 Billion Colors (10 bit)
	Response Time	8 ms (G to G)	8 ms (G to G)
	Surface Treatment	Haze 3 %	Haze 3 %
	Operation Hours (Hours / Day)	24 / 7	24 / 7
	Portrait / Landscape	Yes / Yes	Yes / Yes
Connectivity	Input	HDMI (2), DP, DVI-D, Audio, USB 2.0 Type A	HDMI, DP, DVI-D, RGB, Audio, USB 2.0 Type A
	Output	DP, Audio	DP, Audio
	External Control	RS232C In / Out, RJ45 (LAN) In, IR In	RS232C In / Out, RJ45 (LAN) In, IR In
Mechanical Specification	Bezel Color	Black	Black
	Bezel Width	2.25 mm (T/L) / 1.25 mm (R/B)	2.25 mm (T/L) / 1.25 mm (R/B)
	Monitor Dimension (W × H × D)	1,213.4 × 684.2 × 93.1 mm	1,077.6 × 607.8 × 89.7 mm
	Weight (Head)	20.3 kg	17.8 kg
	Handle	Yes	Yes
	VESA™ Standard Mount Interface	600 × 400 mm	600 × 400 mm
Key Feature	Temperature Sensor, Embedded CMS (Local Contents Scheduling), USB Plug & Play, Fail Over, Background Image (Booting Logo Image, No Signal Image), Sync Mode (RS-232C Sync), Rotation (Screen Rotation), Tile Mode Setting (Max. 15 × 15), Setting Data Cloning, SNMP, ISM Method, Auto Set ID, Crestron Connected <sup>®2)</sup> , Smart Energy Saving, PM Mode, Wake on LAN, HDMI-CEC <sup>3)</sup> , SI Server Setting, W/B Setting by Grey Scale, Scan Inversion		
Environmental Conditions	Operation Temperature	0 °C to 40 °C	0 °C to 40 °C
	Operation Humidity	10 % to 80 %	10 % to 80 %
Power	Power Supply	AC 100 - 240 V ~, 50 / 60 Hz	AC 100 - 240 V ~, 50 / 60 Hz
	Power Type	Built-In Power	Built-In Power
	Power Consumption	Typ. / Max. 130 W / 150 W BTU (British Thermal Unit) 444 BTU / Hr (Typ.), 512 BTU / Hr (Max.)	90 W / 110 W 307 BTU / Hr (Typ.), 375 BTU / Hr (Max.)
Certification	Safety	CB / NRTL	CB / NRTL
	EMC	FCC Class "A" / CE / KC	FCC Class "A" / CE / KC
	ErP	Yes (EU Only)	Yes (EU Only)
Media player Compatibility	OPS Type Compatible	No	No
Software Compatibility	SuperSign CMS, SuperSign Control / Control+, SuperSign WB, SuperSign Media Editor		
Accessories	Basic	Remote Controller, Power Cord, RS232C Cable, LAN Cable, DP Cable, IR Receiver, Guide Bracket, Screws, Manual	
	Optional	Wall Mount (Landscape : WM-L640V, Portrait : WM-P640V)	

<sup>1)</sup> The luminosity ratio of Full Black / Full White color on video input condition.

<sup>2)</sup> Network based control

<sup>3)</sup> Compatibility may differ by equipment.

\* Specifications are subject to change without notice, so please contact LG sales team to verify before ordering.

\* Dimensions & Jack Panels (Read/Side) may differ from the above image, so please contact LG sales team to verify before ordering.



- www.lg.com/b2b
- www.youtube.com/c/LGCommercialDisplay
- www.facebook.com/LGInformationDisplay
- www.linkedin.com/company/lginformationdisplay

LG may make changes to specifications and product descriptions without notice.  
Copyright © 2020 LG Electronics Inc. All rights reserved. "LG Life's Good" is a registered trademark of LG Corp.  
The names of products and brands mentioned here may be the trademarks of their respective owners.

