

ALL - IN - ONE 4K AI Video Bar Kit

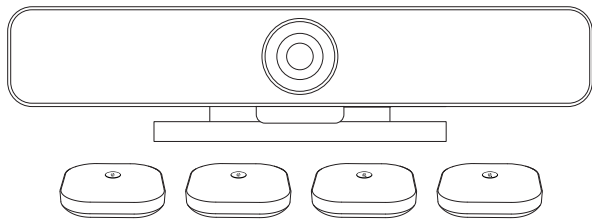

User Manual

What's in the box

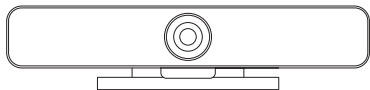

4K Ai Video Bar X 1



Camera Remote Control X 1

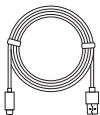

5M Camera USB cable X 1

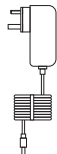

AC Adapter X 1

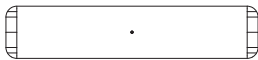

Wireless extension
microphone charging pile X 1



Wireless extension
microphone X 4

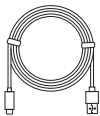

1.5M Charging pile USB cable X 1



User Manual X 1

Overview

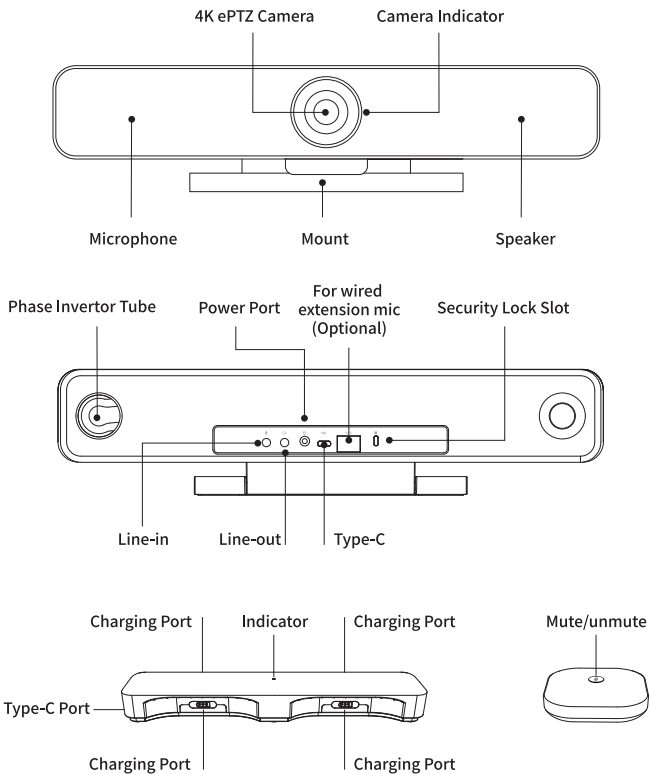

Easy Set-Up

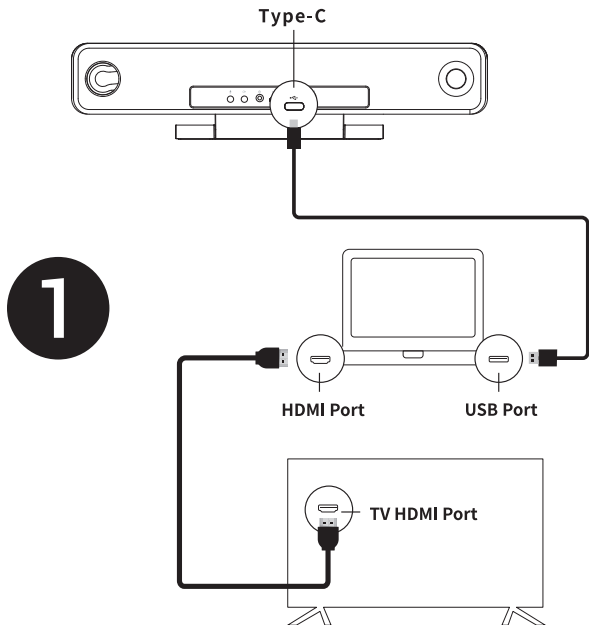

Connect the Video Bar to PC/conference host via USB cable, and connect the PC/conference host to TV via HDMI cable.

2

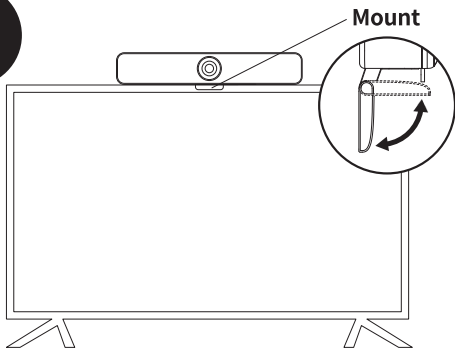

3

Connect the power supply.

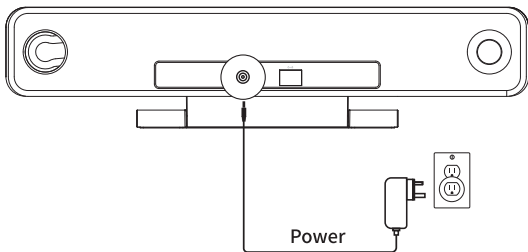

4

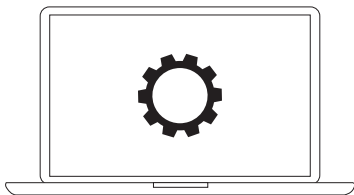

In computer/conference software settings, choose the source of camera, microphone and speaker from the usb video bar.

Camera indicator light status

The camera indicator light will turn blue when camera program is running, It will turn red when microphone is muted. For other normal conditions, the light will be white.

Camera preset settings

Adjust the camera view to the position you want to preset, then long press 1 (or 2, 3) button for 2 seconds. After a hint tone, camera preset 1 is set successfully. Repeat the above steps, press 1, 2, 3 keys respectively, you can set 3 preset positions in total. Repeating the same key will overwrite the previous preset and update it to the latest preset.

Camera Remote Control

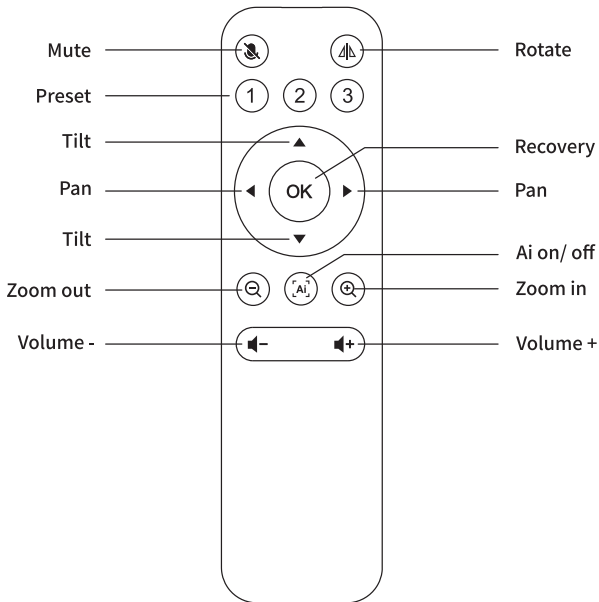



About Wireless microphone

1. Power On/off

- Press and hold the extension microphone button for 2 seconds to power on/power off.
- When the extension microphone is not connected with host, it will automatically shut down after 5 minutes.
- When connected, the extension microphones will be shut down at same time while host is shutting down.

2. Host and extension microphone pairing

- Host pairing: Press the remote control buttons (, , ) in sequence, green circle light prompts, host start pairing mode.
- Extension microphone pairing: After power on, press and hold the mute button for 6 seconds, white light flashes, microphone start pairing mode.
- Pairing successful: Both lights stop flashing and always on.

3. Extension microphone charge

Connect extension mic to the charger, the extension mic starts charging. During charging, extension microphone won't be working though connected with host.

- Low battery: orange light flashes
- Charging: orange light on
- Fully charged: green light on

Notice:

When not paired, connect to the charger and remove the extension microphone: the white light flashes instantly.

When paired: Connect to the charger and remove the extension microphone: Synchronize the host light.

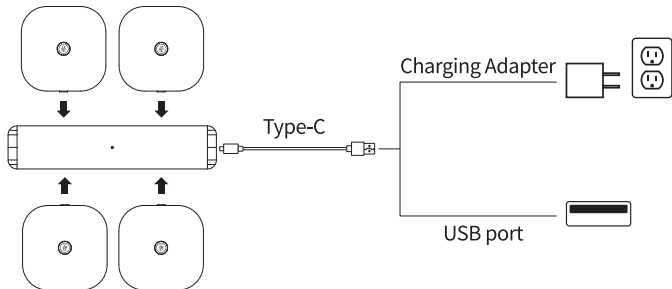

(Charging diagram)

4. Extension mic /Wired mic /Built-in mic

When the host is connected with extension mic /wired mic /built-in mic at the same time, the priority is wired mic, then extension mic, then built-in mic.