



RISE 5105 Motorized Display Lift Floor Stand 50 mm/s (black, EU)

Key Benefits

- Height adjustment range of no less than 980 mm
- Movement speed of 50 mm/s for the heaviest screens with QuickRise™
- TÜV and CE certified
- Specially designed foot for extra safety
- Integrated cable management (CIS®)

Adjust your display to the right height smoothly and safely

A RISE 5105 motorized display lift floor stand is suitable for (interactive flat panel) displays up to 86" and 120 kg max. The lift tilts the screen at a speed of 50 mm/s smoothly and safely with QuickRise™. A travel range of 980 mm is suitable for very low or high positions. Safety first Vogel's display lifts comply with the international safety standards of TÜV and CE (UL and GS on request). The floor stand base is designed for extra safety during use.

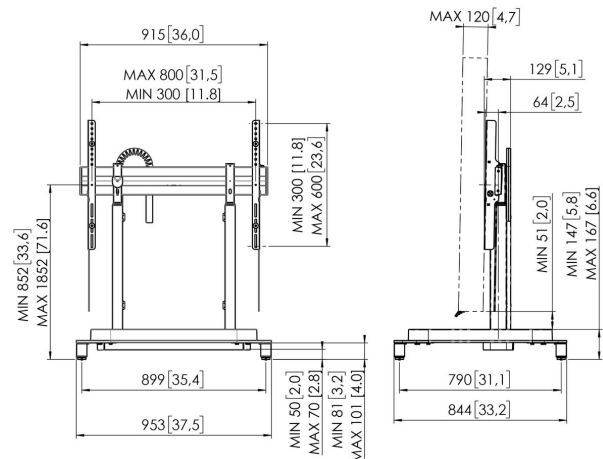



RISE 5105 Motorized Display Lift Floor Stand 50 mm/s (black, EU)



Specifications

Article number (SKU)	7351050
Colour	Black
EAN single box	8712285357541
Height	1188
Width	955
Depth	846
TÜV certified	Yes
Guarantee	5 years
Min. screen size (inch)	65
Max. screen size (inch)	86
Max. weight load (kg/Lbs)	120 / 264.55
Certifications	CE
Max. distance to floor - center display (mm)	1842
Max. horizontal hole pattern (mm)	800
Max. vertical hole pattern (mm)	600
Min. distance to floor - center display (mm)	862
Min. horizontal hole pattern (mm)	300
Min. vertical hole pattern (mm)	300
Motorized	Yes
Height adjustment (mm)	980

VOGEL'S HOLDING BV (©)

All rights reserved.
Subject to printing errors,
technical and price
amendments.

Date: 2022-08-30



Vogel's. For Sure.