

SPROLINK®

www.sprolink.com



Goshare

USER MANUAL

Instruction

Package

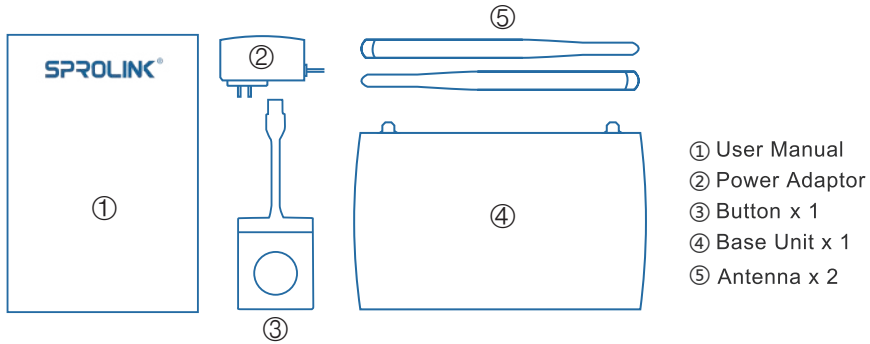

1 Install antenna to expand WiFi coverage

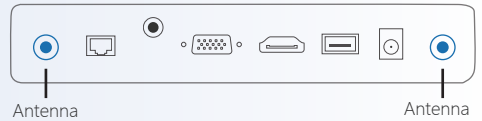

2 Build connection between display and base unit by HDMI or VGA cable. Power on device. The welcome default page will pop out after 30s.

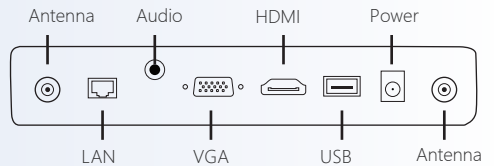

3 Plug the button into laptop or any other HDMI Source. The blue indicator will stop blinking after paired.

If use USB button need to install USB driver for the first application.

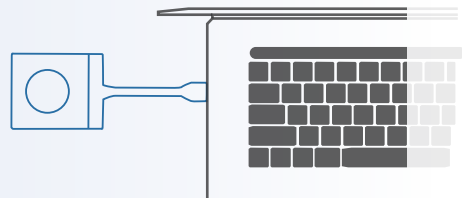

- ① After button paired with base unit successfully, the blue indicator will constantly lighted. Click button to share content to display. The indicator will turn red while sharing content.
- ② If need to stop content sharing, Click button again to log out.



Button Standby



Content Sharing

Web Setting

The default IP for base unit configuration is 192.168.118.1. Connect PC into Goshare WiFi network, Use explorer to login web setting page.

Default User ID: admin Password: admin.

1

OS Version: V2.6.1-H
 Wi-Fi IP: 192.168.118.1
 Wi-Fi SSID: SPROLINK_Goshare

2 Adjust output resolution of base unit



3 Adjust network parameters

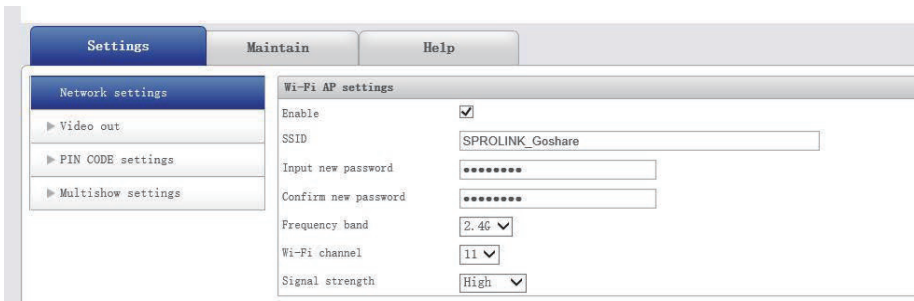

Wired and Wireless Bridging

Goshare support wired or wireless bridging to realize content sharing without interrupt Internet access. Connect LAN port or wireless card of base unit with router for wired or wireless bridging.

The screenshot displays a web-based configuration interface for a device. On the left, a sidebar contains a menu item labeled "Multishow settings". The main content area is divided into two sections. The upper section, titled "Confirm new password", includes a text input field with "*****" and three dropdown menus: "Frequency band" set to "2.4G", "Wi-Fi channel" set to "11", and "Signal strength" set to "High". The lower section, titled "Wi-Fi WLAN settings", contains a label "AP SSID (Supports 2.4G only)", a "Password" field, and a "Connection status" field showing "Connected". A green "Connect" button is positioned below the status field. At the bottom of the interface are two buttons: a blue "Save" button and a white "Cancel" button.

Wireless Presentation with Multiple Platform

iPad/iPhone

- ① Connect iPad/iPhone with Base Unit WiFi.
WiFi SSID:SPROLINK_Goshare

Default Password: 12345678



- ② Slide the screen.
Go to Screen Mirroring page.

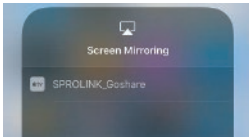

- ③ Choose SPROLINK_Goshare to share content wirelessly.



Mac

- ① Connect iMac with Base Unit WiFi.
WiFi SSID:SPROLINK_Goshare
Default Password: 12345678

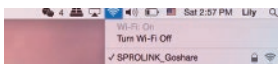

- ② Go to AirPlay icon.
Click SPROLINK_Goshare to share content wirelessly.

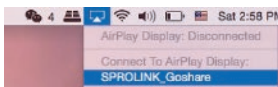

- ③ If cannot find AirPlay icon. Go to System Preference->Displays to enable AirPlay.

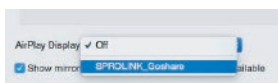

Android

- ① Download APP from the website.
Install the APP in Android Mobile Phone.

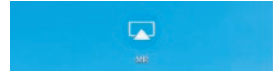

- ② Connect Android phone/tablet with Base Unit WiFi.

WiFi SSID:SPROLINK_Goshare
Default Password: 12345678



- ③ Click MR APP. The software will find the standby base unit automatically.

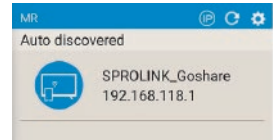

Windows

- ① Download APP from the website. Install the APP in Windows PC.

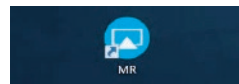

- ② Connect laptop with Base Unit WiFi.
WiFi SSID:SPROLINK_Goshare
Default Password: 12345678

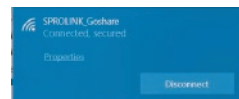

- ③ Click MR APP. The software will find the Standby base unit automatically.





SPROLINK[®]

CREATIVE VIDEO REVOLUTION

XIAMEN SPROLINK SCIENCE & TECHNOLOGY CO., LTD

 Unit 301, No.1734, Gangzhong Road, Xiamen Free Trade Zone, China.

 sales@sprlink.com  +86 592 556 5698  www.sprlink.com